

Access Letters User Guide

Table of Contents

	Introduction	4
1.	Our services	5
2.	The basics	7
	2.1 STEP 1: Prepare your address files	7
	2.2 STEP 2: Set up your systems	8
	2.3 STEP 3: Prepare your sortation files	9
	2.4 STEP 4: Check your design and print	9
3.	Preparing your physical Mailing Items	11
	3.1 STEP 1: Choose your Service	11
	3.2 STEP 2: Fill the Mailing Items	12
	3.3 STEP 3: Address the Mailing Items	12
	3.4 STEP 4: Apply the Indicum	12
	3.5 STEP 5: Segregate your Mailing Items by processing option	15
	3.6 STEP 6: Segregate your Mailing Items by Format	15
	3.7 STEP 7: Segregate your Mailing Items by weight band	16
4.	Choose and fill your Containers	17
	4.1 STEP 1: Choose your Containers	17
	4.2 STEP 2: Order your Containers and Consumables	18
	4.3 STEP 3: Fill your Containers	20
	4.4 STEP 4: Labelling	27
	4.5 STEP 5: Container fills and acknowledgement of under filled Containers	27
5.	Creating your Container labels	30
	5.1 STEP 1: Choose the correct CFL file	30
	5.2 STEP 2: Format your labels	31
	5.3 STEP 3: Print your labels	38
6.	Producing your documentation	41
	6.1 STEP 1: Supply a Posting Docket	41
	6.2 STEP 2: Submit a Manifest	42
	6.3 STEP 3: Submit your Agency overlay report	46
	6.4 STEP 4: Agree the Client Report	47
	6.5 STEP 5: Produce Container documents	47
7.	Calculating your Postage	51
8.	Procedures before you handover mail	52
	8.1 STEP 1: Book your Access Slots	52
	8.2 STEP 2: Submit 7-Working Day rolling forecast	54
	8.3 STEP 3: Submit a 1-day forecast	55
	8.4 STEP 4: Submit your Posting Docket and Manifest	55
9.	Handing over your Postings	56
	9.1 Security procedures	56
	9.2 Health and safety	56
	9.3 Procedures whilst on site	57
10.	Handling non-compliant Mailing Items and Postings	59

APPENDICES:

APPENDIX A: Addressing Mailing Items	82
APPENDIX B: Key National Posting (KNP)	85
APPENDIX C: Zonal Option	88
APPENDIX D: Mixed Weight Service	91
APPENDIX E: Mixing Supply Chain IDs (SCIDs)	94
APPENDIX F: Digital Stamp Indicator	95
APPENDIX G: Advertising Mail	99
APPENDIX H: Advertising Mail Catalogue	101
APPENDIX I: Partially Addressed Mail	103
APPENDIX J: Business Mail Large Letter	108
APPENDIX K: Magazine Subscription Mail	109
APPENDIX L: OCR (discontinued)	111
APPENDIX M: Royal Mail Mailmark	112
APPENDIX N: Royal Mail Mailmark Economy	117
APPENDIX O: Royal Mail Manual Mailmark	119
APPENDIX P: Poll card services	121
APPENDIX Q: eManifest Billing	137
APPENDIX R: Machinable Items (discontinued)	139
APPENDIX S: Trunking Services	141

Introduction

This User Guide provides the operational processes and specifications for you to prepare, present and hand over your Mailing Items to us. The User Guide can also be used by third parties you have engaged to assist you in your mail preparation and presentation.

The User Guide forms part of the Access Letters Contract ('Contract') between Royal Mail Group ('we' or 'us') and Postal Operators to our Inward Mail Centres.

Definitions and Interpretation

Capitalised words in this User Guide have a particular meaning, as defined in Schedule 1 of the Contract. Additionally the following Capitalised words in this User Guide have below meaning:

Approved Indicium	means the Royal Mail Access Indicator and your Customer Access Indicator on a Mailing Item complying with the specification set out in this User Guide and which has been tested by us to our satisfaction and which has been approved by us in writing;
Batch ID	means the unique identifier that is assigned to a Batch once it has been submitted to the eManifest;
Business Mail Large Letter Permitted Items	means the item exceptions to Goods Fulfilment Large Letters listed on the Website (or any replacement URL) which may be updated by us from time to time in accordance with your Contract;
Consolidated Posting	means the total number of Mailing Items which you hand over on any single Working Day to us to convey and deliver and which has not been identified by you as a UCID Posting;
Container ID	means the unique Container identification number that you have designated to the applicable Mixed SCID Container in accordance with the requirements of this User Guide;
Early Access Slot	has the meaning given at Section 8.1(d) of this User Guide;
eManifest ID	means the unique identifier that is assigned to an eManifest once that eManifest has been created;
Goods Fulfilment Large Letter	means a Large Letter which comprises of or contains anything (including but not limited to printed material) which has an intrinsic or resale value (whether or not it has been paid for by the addressee or other recipient), such as: <ul style="list-style-type: none">(a) goods and articles sent in fulfilment of an order or request made to the sender, seller or supplier;(a) gifts and unsolicited goods;(b) collectibles; and spares and replacement parts;
Handover Day	means the Working Day on which a Daily Posting is handed over at the Inward Mail Centres;
Handover Time	means the time specified in the Trunking Scheme Particulars (see Appendix S of this User Guide);
Key National Posting (KNP)	means a posting of exceptional size, volume, shape or geographical bias which requires specific planning to enable the Service Standard to be met;
Mailmark Overlay Report	means an electronic file uploaded by a Participant that links the details of one or more Mailmark Mailings with a relevant UCID Posting declared on the Posting Docket. The layout and format of this file is specified by us and we may change this during the life of this schedule;

Manual Item	means a Mailing Item that you hand over to us that does not comply with the Royal Mail Mailmark or Manual Mailmark specifications set out in the Contract;
Mixed Weight	has the meaning given at Section 3.7(d) of this User Guide;
Mixed Weight Posting	means a UCID Posting or Consolidated Posting containing only Mixed Weight Mailing Items;
Prohibited Packaging	means: (c) padded envelopes; (d) cardboard; and any other stiff or inflexible packaging that cannot easily be manually folded;
Revenue Protection	means our process of sampling and checking your Mailing Items on hand over to us;
Summary Manifest	means a physical paper summary of the total number of Containers by Container type handed over at an Inward Mail Centre;
Vehicle Declaration	has the meaning given at Section 6.2(c) of this User Guide;
Zonal Indicator	means the indicator of the Zone to which a Mailing Item is to be delivered under the Zonal Price Plan.

This User Guide and all other information relating to services and offers can be found on our Website at www.royalmailwholesale.com. Please register to ensure you get easy access to the latest news and updates.

1 Our services

- a. Our full range of Access Services are listed in Figure 1 below. The price you pay for each Access Service will differ according to the sortation level, Format, weight and processing option of your Mailing Items, and the price plan you are on as part of your Contract with us.

ACCESS SERVICE	ATTRIBUTES												
	PROCESSING			FORMAT		WEIGHT BAND					SORTATION		
	Mailmark	Manual Mailmark	Manual	Letter	Large Letter	1 – 100g	101 – 150g	101 – 250g	251 – 750g	Mixed Weight	48-Way Sort	Access 70	Access 70,000
Access 70	•	•	•	•	•	•	•	•	•	•		•	
Access 70 (48-way sort option)	•			•		•					•		
Business Mail Large Letter	•		•	•	•	•		•	•	•		•	
Advertising Mail	•		•	•	•	•		•	•	•	•****	•	
Catalogue Mail			•	•	•	•	•	•	•	•		•	
Partially Addressed Mail	•			•	•	•		•	•	•	•****	•	
Magazine Subscription Mail	•		**		•	•		•	•	•		•	
Royal Mail Mailmark	•			•	•	•		•	•	•	•****	•	
Mailmark Economy	•			•		•					•	•	
Manual Mailmark		•			***	•		•	•	•		•	
Poll Sort			•	•		•							•
General Large Letter***	•	•			•	•		•	•	•		•	

Figure 1: Access Services

**You may hand over Magazine Subscription Mail Large Letters which are up to 10mm in thickness as either Mailmark Mailings or Manual Items. In all other cases Magazine Subscription Mail Postings must be posted using Royal Mail Mailmark. See Appendix K for details.

**The Manual Mailmark Service is available for General Large Letters only. See Appendix O for details.

***For more information on General Large Letters see Section 3.1(a) of this User Guide.

****Letters only.

2 The basics

You are required to sort, segregate and present your Mailing Items at Inward Mail Centres in accordance with the Contract and this User Guide. This section outlines the basic steps you should take to assist you with this.



2.1 STEP 1: Prepare your address files

a. Ensure your Mailing Items are addressed accurately:

- You must ensure that your Mailing Items are fully and accurately addressed to the minimum address and Postcode accuracy requirements set out in Figure 2 below:

ACCESS SERVICE	MINIMUM ADDRESS AND POSTCODE ACCURACY REQUIREMENT
Access 70	90%
Business Mail Large Letter	90%
Advertising Mail	90%
Catalogue Mail	90%
Magazine Subscription Mail	90%
Poll Sort	100%
Royal Mail Mailmark	90%
Mailmark Economy	90%
Manual Mailmark	90%
General Large Letter	90%

Figure 2: Minimum address and postcode accuracy requirements

- If you are on either the Averaged Price Plan Two (Zones) or the Regional Price Plan as part of your Contract with us, and you are declaring your Mailing Items by Zone, you are responsible for uploading each Mailing Item to the correct Zone on the Manifest which you upload to DocketHUB. The minimum Postcode accuracy for each UCID Posting or Consolidated Posting must be provided to us electronically via DocketHUB or such other format as agreed by us. The Postcode must be consistent with the address stated according to PAF®.

b. Use PAF to manage your address data

- The best way to maintain the accuracy of your addresses is to link your customer database to our Postcode Address File (PAF®) by using one of our products based on PAF®. You can use the Postcode Information File (PIF) to append Delivery Point Suffix (DPS) information to Mailmark barcoded postings. To access the latest PAF or PIF file visit the [Royal Mail website](#).

- PAF® contains over 30.8 million UK addresses and 1.8 million postcodes, which we constantly update to maintain its accuracy.
- Royal Mail supplies PAF® as raw data. There are three different PAF® files available:
 1. **Main File:** The master database Main File contains complete postcode and address information for over 30.8 million UK addresses. Main File contains no software and the raw data within it must be processed for use through IT applications;
 2. **Compressed Standard File:** An expanded form of the Main File with over 30.8 million UK addresses in sequential order, as well as Delivery Point Suffix data; or
 3. **Ranges File:** A similar format to the Compressed Standard File, it takes up less space by ranging numbered properties on the same postcode together in one record.

2.2 STEP 2: Set up your systems

a. Using DocketHUB:

- You must use the DocketHUB (or any successor electronic billing system) system to provide us with your Posting details. DocketHUB enables you to:
 - upload your Posting Dockets and Manifests and if applicable your Vehicle Manifests (see Section 6);
 - provide traffic forecasting;
 - book Access Slots; and
 - book driver and vehicle registration.

b. Set up your Access sorting software:

- You will need to set up software to enable you to sort your Mailing Items (see Section 2.3 for further details about sortation levels available).
- It is recommended you use accredited sorting software purchased through a software supplier listed on the [Software Supplier page](#) of our Website.

c. Using Mailmark:

- If you are using the Mailmark Service, to upload your Mailmark eManifests, you can request log on credentials for our eManifest Handling System (eMHS) by emailing our Mailmark team at mailmark@royalmail.com, providing your Mailmark Participant ID and a Supply Chain ID. Appendix M provides more detail on the steps you should go through to set up with Mailmark.
- To use Mailmark, you also need to have software in place to:
 1. create a 'Mailmarked' file i.e. allocating Supply Chain information, unique item IDs;
 2. create the correct barcode string of data with the file; and
 3. print the chosen Mailmark barcode.

Appendix M provides the full details of the specification requirements you must meet when using the Mailmark service.

2.3 STEP 3: Prepare your sortation files

a. Choose your sortation level:

- When presenting your Mailing Items you must choose a sortation level to sort the items to. We offer three sortation levels:
 1. **48-Way Sort:** This sortation level is available if you are posting Letters using our Mailmark option. If you choose this sortation level you will be required to sort your Mailing Items to circa 48 selections based on grouped Postcode Areas. Manual Letter Items and all Large Letters must be sorted to either Access 70.
 2. **Access 70:** If you choose this sortation level you will be required to sort your Mailing Items to circa 86 selections based on Postcode Areas.
 3. **Poll Sort Selections:** This sortation option is unique to our Poll Sort Service. You must sort poll cards to approximately 60,000 selections based on delivery walks, using the specified Election Sort Selection File as contained within the Access Selection Files. You must use the current version of the Access Selection Files.

b. Use our Access Selection Files to sort your Mailing Items:

- Our Access Selection Files provide the key data to enable you to sort your Mailing Items into the sortation levels. The Access Selection Files contain data only and not software. You will need to either develop software to sort your Mailing Items, or purchase a tailor-made product from a software supplier. A list of suppliers can be found on the [Software Supplier page](#) of our Website.
- The Access Selection Files can be downloaded at the [Access Selection Files page](#) of our Website.
- We support our customers to use the most up to date sortation by regularly updating our databases. This revision brings about a new "Version" of the Access Selection Files.

During the lifetime of the Access Selection Files, it is sometimes necessary for us to make changes for the introduction of new Postcodes. If new Postcodes are introduced, then a new Royal Mail Access Selection File "Release" is produced which reflects these additions.

The launch of a new Access Selection File is always "Release 1" and each new release thereafter is then numbered sequentially, until the next Version is produced.

To ensure that your Mailing Items are processed and delivered to the right address as quickly and efficiently as possible, you must use the current Version of the Access Selection Files to sort your Postings. It is also recommended that you use the most recent Release of the Access Selection Files.

When you register at www.royalmailwholesale.com you can opt to be added to a mailing list to receive an email notification when we issue new Releases and Versions of the Access Selection Files. It is your responsibility to ensure that you implement these changes and that the current Version of the Access Selection Files is used.

2.4 STEP 4: Check your design and print

- a. When using our Mailmark or Manual Mailmark Service please ensure that the items meet our print and design requirements. This includes ensuring the location of the Delivery Address, the return address, Mailmark barcode, and the Indicia are correct and that the print quality meets our required standards.
- b. Some products do have constraints around the sealing of items, location of seals and specific areas where there should not be any print.
- c. Please see the Section 3 below for further details.

3 Preparing your physical Mailing Items

When it comes to preparing your physical Mailing Items you will need to decide the format, weight and processing option of your Mailing Items. You will also need to select the Service you will use to post your Mailing Items.

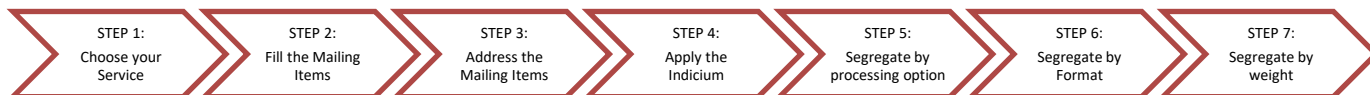

3.1 STEP 1: Choose your Service

a. Meeting the Service specifications:

- The content of your Mailing Items will enable you to choose the appropriate Access Service to use to post your Mailing Items. For certain Access Services there is specification criteria you must meet to be eligible to use the Access Service:

SERVICE	WHERE TO FIND THE SPECIFICATION REQUIREMENTS
Business Mail Large Letter	Our Business Mail Large Letter Service is a content-based service. Eligibility for this Service will be conditional on the contents of the Large Letter and the outer wrapping material used. Refer to Schedule 4, Part 2: Business Mail Large Letter of the Contract and Appendix J of this User Guide.
Advertising Mail	Refer to Schedule 4, Part 2: Advertising Mail of the Contract and Appendix G of this User Guide.
Catalogue Mail	Refer to Appendix H of this User Guide.
Partially Addressed Mail	Refer to Schedule 4, Part 2: Partially Addressed Mail of the Contract and Appendix I of this User Guide.
Magazine Subscription Mail	Refer to Schedule 4, Part 2: Magazine Subscription Mail of the Contract and Appendix K of this User Guide.
Poll Sort	Refer to Appendix P of this User Guide.
General Large Letter	Our General Large Letters service tends to be used for fulfilment and it is the default service for Large Letters that do not meet the specification of the other Services which can be posted with Large Letters. General Large Letters can be sent using Manual Mailmark only providing the Manual Mailmark specification is met.
Royal Mail Mailmark	Refer to Schedule 8, Part 1: Royal Mail Mailmark of the Contract and Appendix M of this User Guide.
Royal Mail Mailmark Economy	Refer to Schedule 8, Part 2: Royal Mail Mailmark Economy of the Contract and Appendix N of this User Guide.
Royal Mail Manual Mailmark	Refer to Schedule 8, Part 2: Royal Mail Manual Mailmark of the Contract and Appendix O of this User Guide.

3.2 STEP 2: Fill the Mailing Items

a. What can and cannot be contained in a Mailing Item

- We cannot carry **prohibited items** through our Access postal network because they are forbidden further to international conventions and/or UK laws and regulations.
- We can only carry **restricted items** in certain circumstances.
- We also limit our liability on **valuable items** and request you do not send valuables through our Access postal network.
- A full list of prohibited items, restricted items and valuable items can be found at www.royalmailwholesale.com/download-user-guides. These lists may be amended from time to time in line with legal requirements or safety practises.
- In addition to the above, you must not send items that contain scam mail or any other similar material, including but not limited to items or mail sent in furtherance of a fraudulent or criminal act, or which in our reasonable opinion is intended to deceive the recipient into parting with money or other assets. For the avoidance of doubt, failure to comply with this requirement shall not constitute a breach resulting in termination of this agreement. If we have a reasonable suspicion that an item contains material that we consider to be scam mail or any other similar material, we may open that item, delay processing, refuse delivery and/or return the items to you, at your expense. In addition to our rights set out in this section, we may also inform third parties of our concerns in relation to the items you have sent, including the identity of the apparent sender and what action we have taken.

3.3 STEP 3: Address the Mailing Items

a. Format the address correctly on the Mailing Items:

- You must ensure that you meet our addressing standards for both Delivery Addresses and return addresses as set out in Appendix A.
- You must ensure that every Mailing Item is clearly marked with a United Kingdom return to sender address and it is recommended it is located on the reverse of the Mailing Item (refer to Appendix A for more information on addressing standards).
- The use of a PO Box within the return to sender address is optional. If you choose to use a PO Box you can apply on the Royal Mail Website (please note that charges apply) at www.royalmail.com.
- Appendix M (Royal Mail Mailmark) provides specific details of the minimum information, positioning and layout requirements for addresses for each of our Mailmark options.

3.4 STEP 4: Apply the Indicium

a. General conditions for applying Indicium to your Mailing Items:

- All Mailing Items (including unwrapped Mailing Items and Mailing Items within an Agency Posting) must carry a Royal Mail Access Indicator. You may also apply your own Customer Access Indicator if it has been approved by us first. Both of these marks together are referred to as an Indicium.
- An Inward Mail Centre will not accept your Mailing Items if:
 1. they do not bear a Royal Mail Access Indicator; or
 2. they bear your own Customer Access Indicator which we have not pre-approved.

- The Indicium cannot be used to access Royal Mail’s Retail end-to-end services or for any other purpose.

b. How should a Royal Mail Access Indicator look:

- The Royal Mail Access Indicator must comprise:
 1. the Royal Mail cruciform preceded by the words ‘Delivered by’; and
 2. your unique Access Licence Number.

Upon setting up a Credit Account we will issue you with a unique Access Licence Number for your use on all Mailing Items (except when setting up a Credit Account as an Agency Customer in which case the Agency Customer shall use the unique Access Licence Number of its Agent, as described in Schedule 7: Agency Terms of the Contract.

This unique Access Licence Number will be incorporated within the Royal Mail Access Indicator for your use. We will not accept a Posting unless all Mailing Items include and clearly display your unique Access Licence Number.

- An example of the Royal Mail Access Indicator is shown below at Figures 3 and 4 demonstrating the characteristics and positioning requirements when applying a large or small Royal Mail Access Indicator. Our [Indicia page](#) of our Website also provides details of the mandatory print and design specifications for the two sizes available and positioning requirements of the Royal Mail Access Indicator on all Mailing Items. A copy of the actual Indicium template, which you must comply with, will be available to you (once your Credit Account has been set up) to download from the Website. You must get our written approval for all designs and subsequent design changes. We require at least two months’ written notice of design proposals prior to any requested implementation date. You may not use any designs before we have given you our written approval. This notice period allows us to carry out technical testing and other approval procedures.

c. How should a Customer Access Indicator look:

- The Customer Access Indicator is optional for you to use on Mailing Items but there are design and location constraints. Figures 3 and 4 below demonstrate the size and positioning requirements when using either a large or small Customer Access Indicator.
- You must seek approval of your Customer Access Indicator design in line with the approval process set out on the [Indicia page](#) of our Website. For us to manage the operation of Access, unless we otherwise agree, you are limited to a maximum of 5 different designs for your Customer Access Indicator. Negative versions (i.e. a reverse image, for example, white on black) of current approved positive images of Customer Access Indicators are not classed as additional designs, and are included within the maximum 5 designs allowed. These negative images may be tested and must be agreed in writing by us before they can be accepted on Mailing Items.
- The Customer Access Indicator must clearly and uniquely identify you or your carrier (where you use a carrier to hand over Mailing Items to us at Inward Mail Centres) by including either:
 1. your legal entity name, or the legal entity name of your carrier; or
 2. a design registered by you or your carrier; or
 3. a trade mark design registered to you or your carrier; and
 4. the Royal Mail Access Indicator (see Section 3.4(b)).

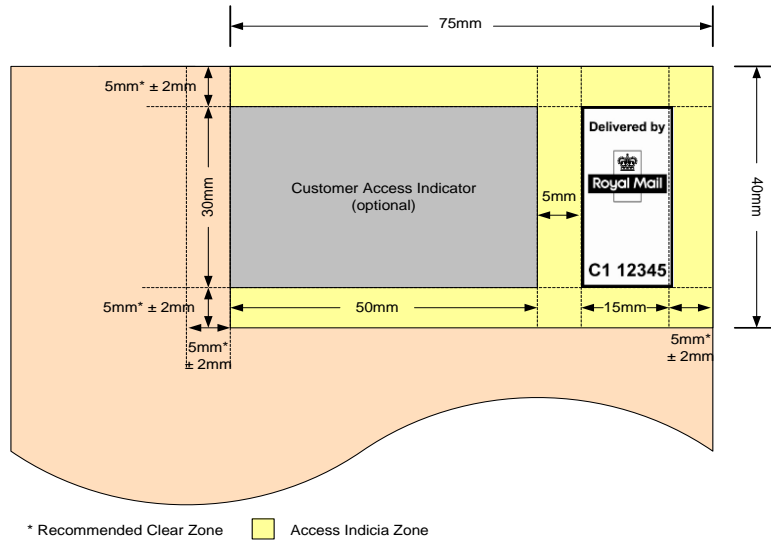

Figure 3: Indicia positioning and size (large)

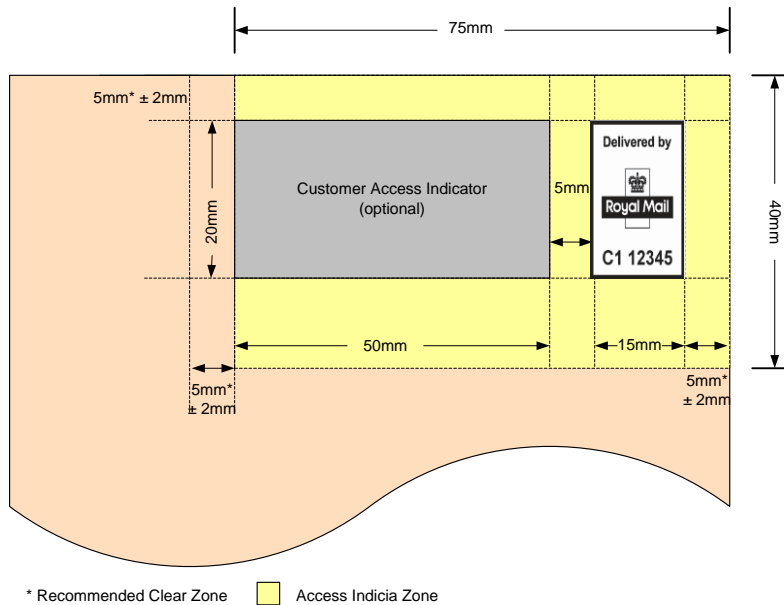

Figure 4: Indicia positioning and size (small)

- **Stamp-like Indicium:** Included as one of your 5 approved designs, you also have the option of creating a stamp-like Indicium which may be printed as an image on to the Mailing Item or can be applied as a self- adhesive label. The stamp-like Indicium must include the Royal Mail Access Indicator (see Section 3.4(b)) and be approved by us before we accept it. Full details of the stamp-like Indicium specification can be found in our [Stamp-like Indicia User Guide](#).
- **Digital Stamp Indicator:** You have the option of creating a Digital Stamp Indicator. This option is only available if you post using Royal Mail Mailmark® and have agreed to Schedule 5, Part 6: Digital Stamps of the Contract. See Appendix F for full details of the approval process and design specifications.

d. Format the Indicium correctly on the Mailing Item:

- You must ensure that you position and lay out the Indicium in line with our requirements set out in this User Guide.
- Appendix M (Royal Mail Mailmark) provides full details of the positioning and layout requirements for Indicium for the Mailmark option.

3.5 STEP 5: Segregate your Mailing Items by processing option

a. There are three options to choose from – Mailmark, Manual Mailmark or Manual Item:

- **Mailmark** requires you to apply a barcode to each of your Mailing Items to enable our sortation and sequencing machines to read them. Adding a Mailmark barcode to each mailing item provides you with performance reporting of your Mailing Items when they are machine processed. This enables you to predict delivery and identify performance improvement opportunities. Appendix M provides full details of the specification requirements for you to meet when using the Mailmark option;
- **Manual Mailmark** can be used for General Large Letters only subject to those General Large Letters meeting the specification requirements at Appendix O; and
- **The Manual Item option** should be used for your Mailing Items that do not meet the Mailmark or Manual Mailmark specifications.

b. Segregate your Mailing Items by processing option:

- Mailing Items within a Posting, UCID Posting or Consolidated Posting must be split into Containers and presented to us by Mailmark, Manual Mailmark or Manual Items.

3.6 STEP 6: Segregate your Mailing Items by Format:

a. Are you posting a Letter or Large Letter?

- When posting Manual Items each Letter or Large Letter must comply with the following range of physical parameters:

	LETTER	LARGE LETTER
Dimensions	Minimum – 100mm x 70mm Maximum – 240mm x 165mm	Maximum – 353mm x 250mm
Thickness	Maximum - 5mm	Maximum - 25mm
Weight	Maximum – 100g	Maximum – 750g

- If you are posting using the Mailmark or Manual Mailmark options, Appendix M (Royal Mail Mailmark) and Appendix O (Royal Mail Manual Mailmark) respectively provide full details of the physical parameters which each Format must meet for each of these options.
- For Mailing Items which have an outer cover, and are posted as a Manual Item or using Manual Mailmark, we will exclude the outer cover, provided it is flimsy and easily folded, for the purposes of calculating the length and width size parameters of the Mailing Items.
- For Mailing Items which have an outer cover, and are posted using Mailmark we will include the outer cover, for the purposes of calculating the length and width size parameters of the Mailing Items.
- We also have specific dimensions design requirements which you must comply with when posting poll cards. See Appendix P of this User Guide.

b. Segregate your Mailing Items by Format:

- Each Posting must be segregated into Containers as Letters and Large Letters. Additionally you must split each UCID Posting or Consolidated Posting within a Posting by Letter and Large Letters.

3.7 STEP 7: Segregate your Mailing Items by weight band

a. Choose your weight band:

- Figure 1 provides details on the weight bands which are available according to the Service and Format of your Mailing Items.

b. Segregate your Mailing Items by weight band:

- Once you have segregated your Mailing Items by Format, you must further segregate those Mailing Items according to the weight band.

c. What is Mixed Weight?

- Mixed Weight is a presentation option for Large Letters only allowing you to hand over Large Letters of different weight bands within a Container at an Inward Mail Centre, unless you are posting Catalogues (in which case the Mixed Weight rules within Appendix H will apply to those Catalogues). You may use this presentation option if you have signed up to Schedule 5, Part 1: Mixed Weight of the Contract and completed the implementation timeline with us successfully. Your Access Account Director will be able to advise of the timescales involved.
- Appendix D provides full details of the presentation requirements you must meet when presenting Mixed Weight.

4 Choose and fill your Containers

Once you have prepared your physical Mailing Items, you will need to place the Mailing Items into Containers ready for presenting to us.



4.1 STEP 1: Choose your Containers

a. Choosing an approved Container:

- You must present Mailing Items to us in an approved Container. You may not use any containers other than those permitted under your Contract to deliver mail to our Inward Mail Centres.
- We have three types of Container you can choose from:
 1. **Tray.** To use Trays to present your Mailing Items, you must have signed up to Schedule 6, Part 1: Tray Loan of the Contract. You can find the schedule on the [Contracts page](#) of our Website;
 2. **Bag;** or
 3. **Auto Level Packet Sleeve (ALPS).** ALPS must be used in-conjunction with Yorks. To use ALPS and Yorks to present your Mailing Items, you must have sign up to both a York and ALPS optional schedule of the Contract. You can find the York and ALPS optional schedules on the [Contracts page](#) of our Website.
- There are also options available to present Mailing Items without wrapping or envelopes (see Section 4.3(d)) or in strapped bundles or unbagged (see Section 4.3(e)).

b. Choosing the correct Container according to Format:

- The three Container types are restricted depending on whether you are posting Letters or Large Letters, as illustrated in the table below:

FORMAT	CONTAINER		
	Tray*	Bag	ALPS*
Letters	•	•	
Large Letters (up to 10mm thickness)	•	•	
Large Letters (more than 10mm thickness AND less than 240mm x 165mm in size), including General Large Letters	•	•	•
Large Letters (more than 10mm thickness AND more than 240mm x 165mm in size)		•	•

**Trays and ALPS enhance mail hygiene and enable for more efficient processing of certain Mailing Items. We offer lower prices are available for Mailing Items when presented in Trays. You can view our prices on the [Price List page](#) of our Website.*

4.2 STEP 2: Order your Containers and Consumables

a. General conditions relating to Containers and blank labels and bag ties (Consumables):

- Containers and Consumables (and any other such property we may introduce from time to time) we supply to you shall remain our property at all times.
- Containers and Consumables shall not be used by you or any 3rd party suppliers for any other purpose than carrying out your obligations of this User Guide and your Contract.
- You shall return all property to us upon termination of your Contract or otherwise as we may reasonably request.
- You shall keep the property in the safe custody and in reasonably good condition, allowing only for reasonable wear and tear.
- We shall be entitled to inspect Containers and Consumables which we supply to you, at any reasonable time, and in the case of misuse of the property by you, your customers or your 3rd party suppliers, we may repossess such property acting reasonably.

b. Supplying Trays to you:

- By request and where mutually beneficial, we will supply you with an agreed volume of our Trays. To place an order for Trays contact DSACC by emailing DSACC@royalmail.com.
- The supply will be in a ratio appropriate to your daily requirement which is determined by DSACC based on average daily handover.
- To facilitate efficient procedures in the supply chain no other tray design is permissible. If we introduce new designs of Trays, you shall accept these Trays that we provide.
- You need to allow an appropriate lead time for the supply of trays, which will vary according to various factors, including the time of year. Therefore you must notify additional requests for our Trays to DSACC as soon as possible but no less than 10 Working Days prior to the Posting for which they are required. If you are posting Key National Postings (KNPs) (see Appendix B) you must notify additional requests for Trays to DSACC no less than 14 Working Days prior to the KNP for which they are required.
- We operate a one-for-one exchange of Trays with you at the point of handover, or with your carrier on your behalf, at each Inward Mail Centre at which you hand over Mailing Items, meaning we will lend you one empty Tray for each Tray you present. This process must be supported by an accurate waybill (see Section 6.5(a)) for audit trail purposes.
- After you collect Trays from us, you shall distribute them to your premises.
- You shall not remove any labels or markings that we or the manufacturers put on the Trays. You shall not allow any other labels or markings to be put on the Trays without our prior written consent.
- If you do not have enough Trays, you must bring Mailing Items to our Inward Mail Centres in another Container subject to meeting the requirements for that Container, for example Format, as set out in this User Guide.

c. Supplying Yorks and/or ALPS to you:

- We do not supply Yorks or ALPS to you unless it is operationally mutually beneficial to do so.
- Yorks and ALPS may only be purchased, hired or leased in accordance with the relevant York and ALPS optional schedule of the Contract which you have agreed to. Whether purchased, hired or

leased, York and ALPS must only be used in accordance with the terms of the relevant optional schedule and this User Guide.

- All requests for Yorks and/or ALPS should be notified to DSACC as soon as possible but no less than 10 Working Days prior to the Posting for which they are required.
- We operate a one-for-one exchange of Yorks and ALPS with you, or your carrier on your behalf, at each Inward Mail Centre at which you hand over Mailing Items, meaning we will exchange with you one empty York or ALPS for each York or ALP you present to us. This process must be supported by an accurate waybill (see Section 6.5(a)) for audit trail purposes.
- After you collect Yorks or ALPS from us, you shall distribute them to your premises.
- In relation to Leased Yorks and Leased ALPS, you shall:
 1. treat all Leased Yorks and Leased ALPS in your possession or control with care and take all reasonable steps to prevent damage or loss to them; and
 2. not use fork-lift trucks (or any other vehicle, machinery or equipment reasonably likely to damage them) to transport, load, unload or otherwise deal with the Leased Yorks and Leased ALPS.
- You shall not remove any labels or markings that we or the manufacturers put on the Yorks or ALPS. You shall not allow any other labels or markings to be put on the Yorks or ALPS without our prior written consent.
- If you do not have enough Royal Mail Yorks, you may bring Mailing Items in bags, Trays or strapped bundles to our Inward Mail Centres in your own containers, including Customer Yorks, as long as if you carry mail in containers which are not Customer Yorks you transfer the mail into Royal Mail Yorks at the loading dock at our Inward Mail Centres before hand over to us. You may not use any containers other than Royal Mail Yorks or Customer Yorks to deliver mail to our Inward Mail Centres.
- If you do not have enough Royal Mail ALPS, you may bring Large Letters over 10mm thick to our Inward Mail Centres in bags or strapped bundles. You may not use any containers other than Customer ALPS, Royal Mail ALPS or bags for the handover of Large Letters over 10mm thick.
- To allow for work in progress, you will need to purchase or lease Yorks and/or ALPS at a minimum ratio of 3:1 for your peak volume usage. For example if on your peak handover you give us 5000 Yorks, you must lease or purchase 15000 Yorks to allow for works in progress.
- If you use your own containers (i.e. containers which you have not purchased, hired or leased in accordance with the relevant York and ALPS optional schedule of the Contract), you must unload all Mailing Items from your containers at the point of handover to us. We will reject any such containers which you try to hand over to us with the Mailing Items still loaded within. We will supply suitable Containers at the point of handover for you to place Mailing Items into.
- If we introduce new designs of Royal Mail Yorks or Royal Mail ALPS, you shall accept the Royal Mail Yorks or Royal Mail ALPS that we provide you with whether or not they are of that new design.

d. Supplying bags to you:

- Each Working Day, we will supply bags to you, as you may reasonably require, according to a pre-agreed site/volume schedule. The schedule will be reviewed by DSACC regularly, tracking the average monthly bag usage and availability of bags in the Inward Mail Centres, and your Account Director will discuss the usage and availability with you following DSACC's review.
- Where you require additional bags you must provide at least 5 Working Days' notice to DSACC. For requests for more than 100,000 bags a week, at least 10 Working Days' notice must be given to DSACC. You must collect ad-hoc bags from the location which we specify.

- Our bags must only be used for the final bagging process prior to handover to the Inward Mail Centre. Empty bags must be collected from our specified Inward Mail Centres at a time agreed by you and DSACC.
- We do not supply Yorks for the transportation of empty bags. If you require bags to be transported in Yorks, you must provide enough of your own Yorks for the bags required. Alternatively, you can loose load the bags. It is your responsibility to load the vehicle. Should you wish to introduce your own, wheeled, braked container that can be nested for the purpose of bag collection, we will need to carry out a national risk assessment and a local risk assessment on the container to determine if it is acceptable for the safe collection of bags and the associated processes, for example storage. You must provide details of Safe Systems of Work for the container type and we will need to be trained in its use.

e. Supplying blank labels and bag ties to you:

- We will supply Consumables to you, as you may reasonably require, according to a scheduled monthly supply based on your average monthly Container use. This volume will be reviewed regularly to track the average monthly usage.
- You shall only order blank labels and bag ties from DSACC by emailing DSACC@royalmail.com. Where additional ad-hoc Consumables are required you must give DSACC at least 5 Working Days' notice of your requirements. We will assess your requirements and use reasonable efforts to provide your required amounts within the notice period. Consumables ordered will be delivered to your nominated address as detailed in the Letters of Responsibilities agreed between us, you and your Carrier.
- We provide blank labels and bag ties which must be used for final containerisation, labelling and sealing prior to handover to us.
- Consumables will be supplied in multiples of the appropriate box fills. We do not provide any other consumable items, such as rubber bands and bundle ties.

4.3 STEP 3: Fill your Containers

a. Presenting your Mailing Items in bags:

Bundling Mailing Items

- Mailing Items of a similar weight, shape or size must be bundled securely within bags. The number of Mailing Items in each bundle will depend on the nature of the Mailing Items which will normally be determined by their size and thickness.
- Each Standard Selection Code may consist of several bundles.
- Each individual Mailing Item must be securely sealed.
- There is no minimum limit to the number of Mailing Items in a bundle provided they are of a similar weight, shape or size. However as many Mailing Items as possible must be included within each bundle (subject to the maximum Container weight).
- There is no maximum limit to the number of Mailing Items in a bundle provided the bundles do not exceed the maximum weight limit of the Container in which the bundle is then placed, and the thickness of the bundle does not exceed that which can be held in one hand (approximately 15cm).
- All bundles must be tied with the Mailing Items facing the same way, using sufficient strapping or rubber bands, so that they do not burst open in the bag, given reasonable handling conditions. If Mailing Items are 'wedge-shaped' and the spine prevents you from stacking the bundle of Mailing

Items evenly, they should be counter-stacked with the top half facing the opposite way to the bottom half.

- Mailing Items should be bundled in such a way as to not damage the individual Mailing Items.
- Once the ties or strapping have been removed the Mailing Items must be capable of being handled individually and must not be stuck to one another for any reason, including any stuck together due to the use of any adhesive in the mail production process.
- Bundles that become insecure due to inadequate strapping or other material used will be subject to Adjustments¹.

Bagging Mailing Items

- Once the Mailing Items are bundled, they must be bagged. The maximum bag weight we will accept is 11kg, including the weight of the bag, bag tie and label. Depending on the volume of the Posting, more than one bag for a Standard Selection Code may be needed. To make sure the bag weight will not exceed 11kg, it is usual practice to mark the bag breaks on the Mailing Items. You must make sure that more than one bag is used if the weight of a bag, bag tie and label exceeds 11kg.
- You must make sure that all Mailing Items for a single SSC are included in one bag unless the maximum weight is exceeded. Where possible all Mailing Items within each bag should be of a similar weight, shape or size. The bag neck should be securely tied/strapped with a bag tie provided by us. Bags must not be tied through the 'D' rings.
- To determine when a new bag must be started and a new label provided, you will need to distinguish where the Mailing Items for one SSC ends and a new SSC begins. There are a variety of ways to do this, for example by printing the SSC near the address which determines that it is time for new bag when the code changes. Software can be set up to print a distinguishing mark (e.g. three asterisks) on the last item for each bag in each SSC, or you may work through the printout of its sorted mailing list and mark it by hand. You can produce a blank label as a SSC break indicator between each SSC.
- It is recommended that the long tail ends and loose ends of bag ties are tucked and wrapped in to the band formed by the bag tie to prevent it sticking out and causing injury to anyone handling the bags.

b. Presenting your Mailing Items in Trays:

- Each tray shall contain only Letters or Large Letters for a single SSC.
- Trays weigh 1kg. The Tray, the label and the Mailing Items within must not weigh more than 10kgs.
- You shall ensure that you do not load Trays into Yorks at our Inward Mail Centres in excess of the weight limits for Yorks of 250kg, or any other maximum weight limits that we may specify from time to time.
- Efficient use of Trays is mandatory as it is beneficial to the carrier and us. Consequently, for any single SSC, a Tray must be full before another Tray is used, unless the maximum tray weight is exceeded.
- Mailing Items to Guernsey (GY), are excluded from being presented in Trays for security and handling safety and must be presented in bags in accordance with Section 4.3a, unless you have

¹ When sending Large Letter Mailing Items, the requirement to bundle as described in this Section 4.3 only applies to Advertising Mail, Magazine Subscription and Business Mail Large Letters. General Large Letters of a physical size and/or shape which prevents them from being securely bundled can be loose within bags.

agreed to Schedule 5, Part 2: Tray Decanting of the Contract in which case you can present such Mailing Items in Trays.

- When presenting Letters or Large Letters in Trays the following rules apply:

FORMAT	PRESENTATION REQUIREMENTS
Letters	<ul style="list-style-type: none"> Letters must be stacked vertically on their long edge; Letters must be inserted upside down with the Access Indicium facing the Tray label (see Figure 5);* Letters must be loose loaded in Trays. They should not be bundled. Letters must not be packed tightly into Trays (see Figure 5); Letters must not be bundled. <p>NB: *The only exception to letters being placed upside down is for machineable postcards which, due to the thickness, may be placed upright in the tray with the Indicium facing the tray label.</p>
Large Letters (less than 240mm x 165mm in size)	<ul style="list-style-type: none"> The same presentation requirements as for Letters apply; Additionally, Large Letters must be laid horizontal with the Delivery Address facing the top, and placed as high as the plimsol line within the Tray (just beneath the open handle) – this allows the Trays to be carried and lifted (see Figure 7).
Large Letters (less than 10mm thickness AND more than 240mm x 165mm in size)	<ul style="list-style-type: none"> If placing the Large Letters into the Tray in a landscape position, the address and Access Indicium must be face up in the Tray, and with the Access Indicium away from the tray front and label (see Figure 6); If placing the Large Letters into the Tray in a portrait position, the address and Access Indicium face up in the tray, and with the Access Indicium adjacent to the tray front and label (see Figure 6); Large Letters must not be bundled; Large Letters must be laid horizontal and placed as high as the plimsol line within the Tray (just beneath the open handle) – this allows the Trays to be carried and lifted (see Figure 7).

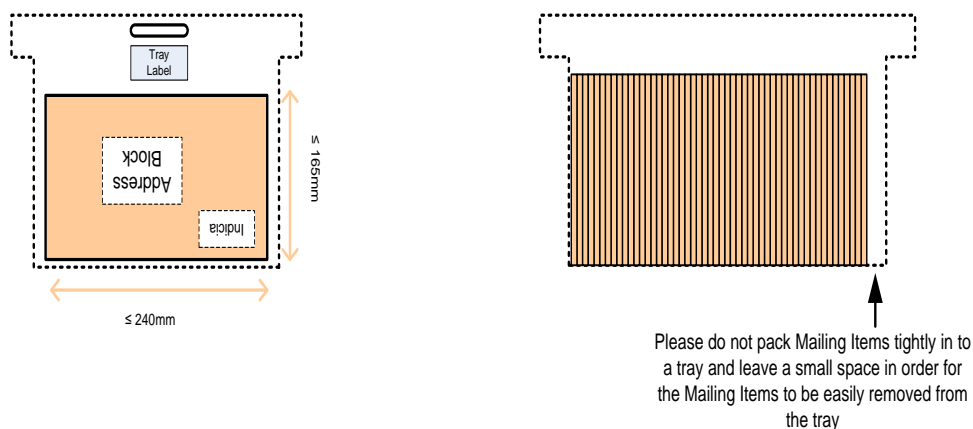

Figure 5: Mailing Item stacking requirements in Trays (cross section)

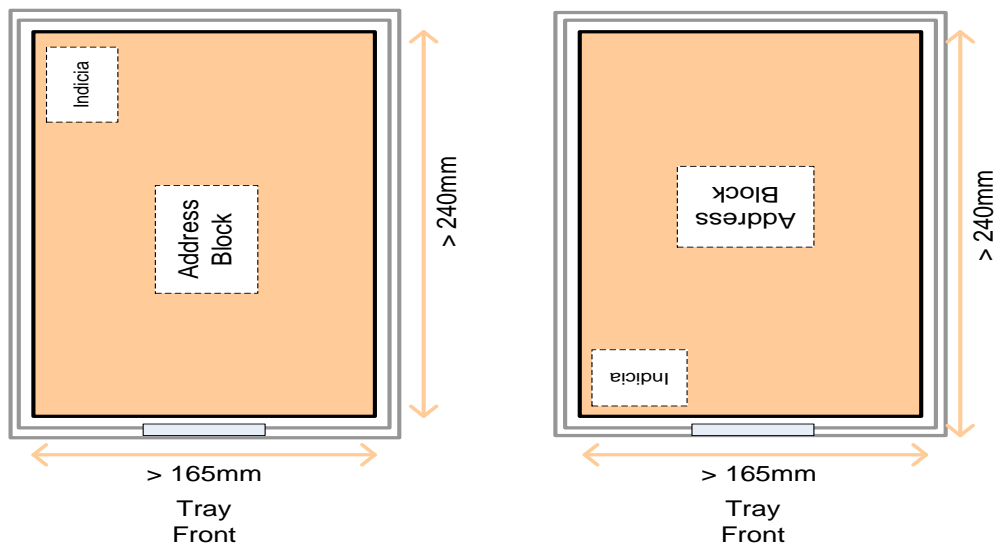

Figure 6: Mailing Item stacking requirements in Trays (landscape and portrait)

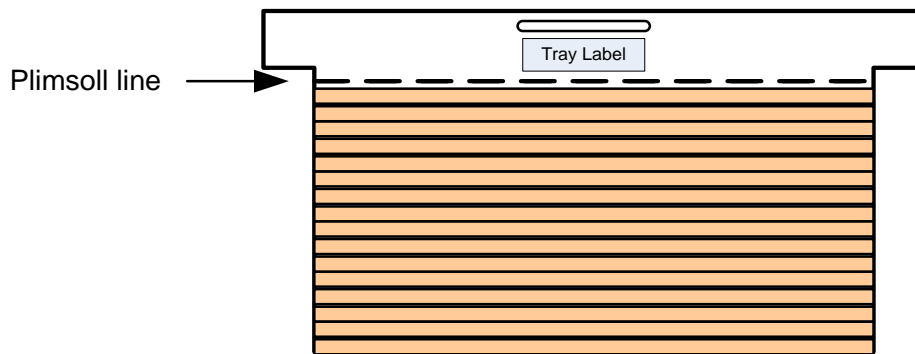

Figure 7: Plimsoll line fill

c. Presenting your Mailing Items in ALPS:

- ALPS must only be used when fitted within Yorks. For clarity, Mailing Items must not be loose loaded into Yorks that are not fitted with ALPS.
- You shall ensure that you do not load any York in excess of 250kg or such other maximum weight limits that we may specify from time to time.
- Efficient use of ALPS Containers is a requirement that is to the benefit of both the carrier and us. Consequently, for any single Standard Selection Code, an ALPS Container must be full before another ALPS Container is used for the same Standard Selection Code unless the maximum York weight of 250kg is exceeded.
- Large Letters must be placed loose into each ALPS because we acknowledge that the physical dimensions and weight of the individual Large Letter may mean it is not suited to being bundled. Each Large Letter must be securely sealed.
- Each ALPS shall contain only Large Letters for a single Standard Selection Code. Standard Selection Codes must not be mixed within an ALPS.
- Mailing Items to Guernsey (GY) are excluded from being presented in ALPS for security and safety and must be presented in bags in accordance with Section 4.3(a). A Mailing Item for Guernsey that

cannot fit into a standard Royal Mail bag due to its physical dimensions must be presented and labelled as an individual Container.

d. Presenting your Mailing Items without wrapping or envelopes (Unwrapped Mailing Items):

- We may accept Mailing Items in Containers (including when used in conjunction with Advertising Mail) without wrapping or envelopes.
- For all Unwrapped Mailing Items:
 1. All Mailing Items must be included in the 7 Working Day rolling and Forecasts and in the 06:30 DocketHUB upload (see Section 8.2 and 8.3).
 2. Each Mailing Item will be priced according to Format. If you post machineable Letters unwrapped, they will be priced as Large Letter format.
 3. We will destroy any Mailing Items that are undeliverable through lack of address particulars or because the address covers have become torn in transit;
 4. We cannot give any assurance on redirected Unwrapped Mailing Items;
 5. We cannot accept responsibility for damage in transit for unwrapped Mailing Items and any recipient complaints will be referred to the sender.
- For unwrapped Mailing Items posted as Manual Items:
 1. Each Mailing Item is to be pre-addressed on the cover, the Delivery Address positioned below and to the left of the Indicum;
 2. Size permitted: The maximum size of the unwrapped Mailing Item is 324mm x 458mm and the minimum size is 95mm x 145mm;
 3. Presentation: Large Letters must be bundled when presented in bags and must be loose when presented in ALPS;
 4. If Mailing Items are presented in bundles without bags, the bundles must be crossed strapped or alternatively wrapped in polywrap of 30 microns and the posting must also meet the requirements of Section 4.3(d);
 5. Labelling: White labels are required;
 - a. Bundles held together by polywrap the bundle label must comprise of a white adhesive label of comparable size to the normal bag label (12cm x 5cm), and be applied to the outside of the polywrap. The label must be applied in such a position that it obscures the Delivery Address of the item beneath the wrapping to avoid the bundle being perceived as a single item of mail.
 - b. For Mailing Items presented in bundles without bags, strapped, the label must be attached securely to the strapping material used.
 6. Design: All pages of each Mailing Item in the unwrapped Posting must be of the same size and fixed together by staples or other means with the exception of the facing cover of the item may be a smaller size (e.g. either half the length or the width of the rest of the Mailing Item). This is providing that it is securely affixed to the spine of the Mailing Item.
 7. Inserts: Loose inserts are not permitted.

8. Onserts: Onserts are not permitted.
- For unwrapped Large Letters that are machinable:
 1. You may post only using Mailmark. Note: Unwrapped Letters can be sent using Mailmark or Manual Mailmark, provided such items comply with the Large Letter unwrapped specification and will be priced as Large Letter format.
 2. Size: The maximum size of the unwrapped Large Letter is 345mm x 245mm x 10mm and the minimum size is 145mm x 95mm x 0.5mm;
 3. Design:
 - a. You must meet the existing rigidity and stiffness requirements as specified in Appendix M (Royal Mail Mailmark) of this User Guide;
 - b. All pages (including the cover) must be of equal size;
 - c. No loose inserts or 'onserts' are permitted (e.g. pens, badges etc.);
 - d. All pages must be secured to the binding;
 - e. The spine must always be on a long edge furthest away from the Indicum;
 - f. The spine must be glued or stapled. (Punch & bind bindings are not permitted);
 - g. The cover of the Large Letter must have a paper weight of more than 50gsm;
 - h. The pages of the booklet must have a paper weight of more than 50gsm;
 4. Presentation: Unwrapped Large Letters must be presented in Trays. Large Letters that are less than 240mm x 165mm in size must be presented with the spine towards the top of the tray as illustrated in Figure 8 below:

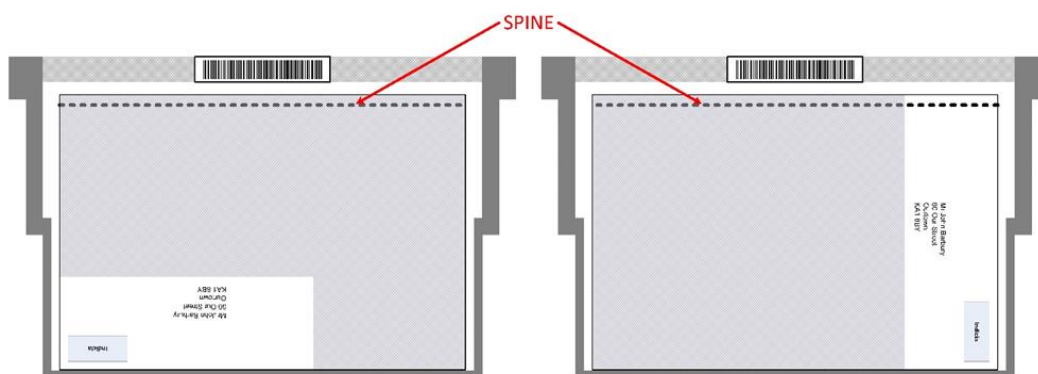

Figure 8: Unwrapped Mailing Items less than 240mm x 165mm in Trays

Unwrapped Large Letters that are more than 240mm x 165mm in size must be presented with the spine of the Large Letter on the right of the Tray when viewed from above as illustrated in Figure 9 below:

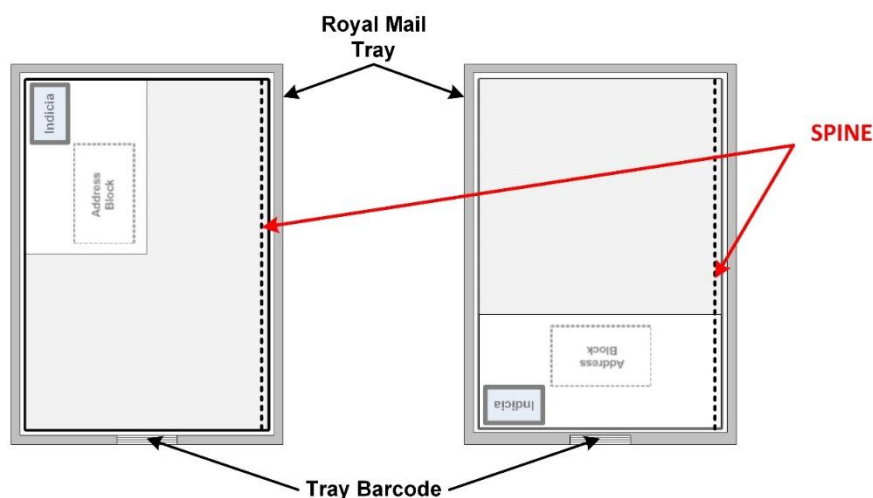

Figure 8: Unwrapped Mailing Items more than 240mm x 165mm in Trays

e. Presenting your Mailing Items strapped bundled or unbagged:

- You must post at least 4,000 Mailing Items to present Mailing Items as strapped bundled/unbagged.
- All strapped bundled Mailing Items must be included in the 7-Working Day rolling and 1-day forecast and in the 06:30 DocketHUB upload (see Section 8.2 and 8.3).
- The dimensions of the Mailing Item must be between 125mm x 176mm and 324mm x 458mm in size.
- Each Mailing Item will be priced according to Format.
- Bundles must be either:
 9. securely double strapped (i.e. each bundle must be cross strapped, both lengthways and widthways). This additional strapping serves the same purpose as bags and helps protect the bundles whilst in transit. For Royal Mail Mailmark Letters and Large Letters presented in paper-wrap, customers are permitted to cross strap bundles across the width of the item on the proviso there are a minimum of two straps which are located towards the edge of each bundle. The strength of the strapping application and distance from each strap must be such that there is no risk of the contents of the bundle becoming loose during transit and the bundle being damaged or torn; or
 10. wrapped with polywrap (30 microns).
- Postings that include bundles that are not strapped securely will be returned or subject to Adjustments. It is your responsibility to safeguard the hygiene of mail presented for posting (e.g. mail is free of moisture, clean and undamaged). The tension of any strapping applied to bundles should be such that:
 1. there is no damage to the Mailing Item;
 2. that the edges of the Mailing Item are not damaged in any way when the strapping is removed;

Examples of damage are the items or edges are torn, shredded or turned up in such a way they impact on processing or will provide a negative receiving customer experience

- When Mailing Items are of a single uniform thickness across the whole width and length of the item, they must be faced and bundled in the same direction.
- Where bulky Mailing Items are not of a single uniform thickness across the whole width and length, items must be bundled in such a way that the bundle is level and squared off at the ends. If a Mailing Item is thicker at one end, the items should be counter stacked with the top half of the bundle turned the opposite way to the bottom half. The Delivery Address must still be facing upwards.
- Elastic bands must not be used for holding bundles together. You are required to present bundles either brick stacked or column stacked in Containers.
- Bundles must not exceed the 6.4kg in weight.
- Each bundle must be stacked safely and securely in each York container.
- Individual Mailing Items with a weight up to 100g, or flimsy in construction, must have a bundle height of at least 15cm to maintain rigidity and efficiency when being handled.
- The volume of Mailing Items in each bundle must be maximised to ensure the minimum total number of bundles are presented for a single mailing, subject to sortation requirements. For example, it is not acceptable to present 2 bundles each weighing 3kg, for the same SSC. In this instance a single bundle of 6kg should be presented.
- Mailing Items to Guernsey (GY), are excluded from being presented as strapped bundles for security and handling safety and must be presented in bags in accordance with Section 4.3a.
- Labels must be securely affixed to the bundles.

f. Presenting Mixed Weight:

- See Section 3.7(c) for an explanation of Mixed Weight and Appendix D which sets out the presentation requirements.

g. Mixing Supply Chain IDs:

- If you have agreed to Part 4 of Schedule 5: Mixing Supply Chain IDs of the Contract, you may mix Mailmark Mailing Items belonging to different SCIDs into Containers. See Appendix E which sets out the presentation requirements.

4.4 STEP 4: Labelling

- a. Yellow labels are required for machineable products and white labels are required for Manual Items.
- b. For full labelling requirements and details see Section 5.

4.5 STEP 5: Container fills and acknowledgement of under filled Containers

a. Filling your Containers to the minimum level requirements:

- You must ensure that each Container contains either Letters only or Large Letters only. You must not combine Letters and Large Letters in a Container.
- The table below provides information about the minimum number of Mailing Items (including unwrapped and unbagged Mailing Items) you must fill within a Container:

FORMAT	MINIMUM CONTAINER FILL REQUIREMENTS
Letters	Each Tray or bag must contain at least 25 Letters each weighing no more than 100g.
Large Letters (excluding Large Letters declared as Magazine Subscription Mail)	Each Tray, bag or ALPS must contain at least: <ul style="list-style-type: none"> • 5 Large Letters each weighing no more than 100g; or • 5 Large Letters each weighing more than 100g up to 250g; or • 5 Large Letters each weighing more than 250g up to 750g.
Large Letters declared as Magazine Subscription Mail	Each Tray, bag or ALPS must contain at least: <ul style="list-style-type: none"> • 10 Large Letters each weighing no more than 100g; or • 10 Large Letters each weighing more than 100g up to 250g; or • 10 Large Letters each weighing more than 250g up to 750g.

- You can set your own minimum Container fill requirements to support your own production efficiencies as long as you meet the above minimum Container fill requirements.

b. What happens if you have a Container which is not filled to the minimum fill requirements:

- An Under Volume Container is a Container that does not contain the minimum number of Mailing Items as defined in Section 4.5(a) above.
- If you do not fill your Container to the minimum requirement we may apply the Under Volume Container Charge in accordance with the calculation set out in Section 10 of this User Guide.
- You have an option to use a UCID on your Container labels.

What is a UCID?

- A UCID is an identifying reference (maximum 15 characters) created and assigned by you. It uniquely identifies each of your discrete Customer Entities, Posting Entities and Originating Customers which allows you to associate Mailing Items relating to each separate entity/customer.
- If you choose to identify Mailing Items that have been prepared and sorted discretely from other Mailing Items by use of UCIDs you must first submit your proposed numbering methodology for your UCIDs to your Account Director for our approval. Your numbering methodology for UCIDs must relate to separate Originating Customers, Customer Entities or Posting Entities and we are looking for consistency of use of each UCID number each time the same Originating Customer, Customer Entity or Posting Entity sends Mailing Items with you for hand over to us. We will withdraw the right for you to use UCIDs if your use is not consistent.
- Where a UCID is assigned to a Customer Entity, Posting Entity or Originating Customer, each time you hand over Mailing Items for that particular entity or customer, the same unique UCID must be used. It is mandatory for that UCID to remain unchanged throughout the life of your Contract, except if you have our approval to make changes.
- Each Container forming part of a UCID Posting must be clearly identified with the correct UCID on the Container label (see Section 5.2) and if reasonably required by us must at hand over be clearly segregated from other Containers in a Posting which do not form part of that UCID Posting. The UCID on the Container label must correspond with the UCID number of the Manifest.

How will you be charged if there is a Under Volume Container as part of a UCID Posting?

- Where you present a UCID Posting then one Under Volume Container per Standard Selection Code per UCID per Service used per day will be charged at the Access Charges relevant for that Service. This is subject to all other terms and conditions of the Contract being met.
- Any additional Under Volume Container will be charged the Under Volume Container Charge in accordance with the calculation set out in Section 10 of this User Guide
- For clarity, Under Volume Container Charges are applied in addition to the postage charges for the Mailing.

How we deal with Postings which have more than one Under Volume Container

- Where more than one Under Volume Container is produced, DocketHUB (or other systems we may develop and make available) will select the Under Volume Container per SSC per Service that will be charged at the relevant Under Volume Container Charge on the basis of the following:
 1. The Under Volume Container per SSC with the least number of Mailing Items; or
 2. Where two or more Under Volume Containers have the same number of Mailing Items, the Container with the highest average item weight.
- You shall ensure that the Container fill per Standard Selection Code is maximised.

5 Creating your Container labels

Containers must be labelled with Customer Final Labels (**CFL**), which indicate the destination and contents of the Container and include other information we require to deliver your Mailing Items.

Only labels provided by us and formatted to the specifications set out in this section, may be used for the final containerisation, labelling and sealing of Containers prior to handover to us (rough labelling will not be accepted).

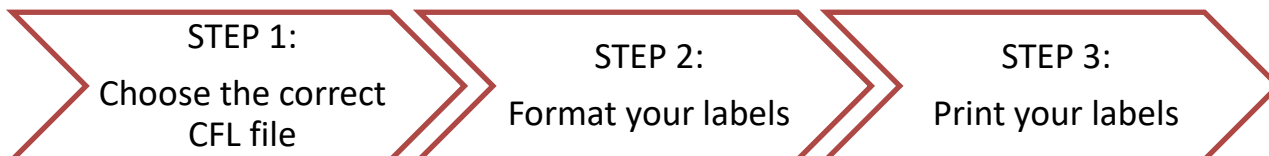

5.1 STEP 1: Choose the correct CFL file

a. Use the latest CFL file:

- You can download the latest Royal Mail CFL file from the [CFL Database page](#) of our Website. You must use the correct and current CFL database file for your labelling requirements.
- The CFL files link the correct Standard Selection Code with the routing and content information that you will require to format your labels.
- Postings made against National Price Plan One, Averaged Price Plan Two (Zones) and the Regional Price Plan (Zones) shall adhere to the labelling instructions for the "National" option where it is referenced in this section on CFL requirements.

b. Use the correct coloured labels:

- Depending on the processability of your Mailing Items, you will need to use either white or yellow labels as illustrated in Figure 8 below. Figure 8 also shows the two data file options available – DSAMAN.DAT (for Manual, Mailmark Large Letter and Manual Mailmark) or DSAMEC.DAT (Mailmark Letter).

	Format		
	Letters	Large Letters	
Access Service and Machinability	Container Label Colour		CFL Data File
Access 70 Manual Item	White	White	DSAMAN.DAT
Access 70 (inc 48-Way Sort) Mailmark Letter	Yellow		DSAMEC.DAT
Access 70 Mailmark Large Letter		Yellow	DSAMAN.DAT
Access 70 Manual Mailmark		White	DSAMAN.DAT

Figure 8: Label colour and data file options

c. File layout:

- Each of the two data files contain information for the labels for your Posting. The information includes the file version (which directly relates to the Access Selection File version being used to sort your data), the Inward Mail Centre or destination office for the Mailing Items and the SSC. The information is laid out in each file as follows:

FIELD	SIZE	TYPE	COMMENTS
Database Version ID	3	Numeric	1 st digit represents version 2 nd /3 rd digit represents release
Destination Office ID	3	Numeric	Unique identifier for each Inward Mail Centre
Standard Selection Code	5	Numeric	Unique identifier for sortation selections linked to a specific Inward Mail Centre or delivery office
Destination Office	30	Alphabetic	Inward Mail Centre or delivery office name
Standard Selection Code Description	30	Alphanumeric	A summary description of the sortation level and Service chosen
			Access 70 Postcode Area (or District) followed the by relevant Postcode grouping
			Access 70 Mailmark Letter - The word PLAN followed by the Plan number
			Access 70 Mailmark Large Letter - Postcode Area (or District) followed the by relevant Postcode grouping
Total	101		Record Length

d. Using our DSADESTN.DAT (Destination Office) file

- Additional to the DSAMAN.DAT or DSAMEC.DAT files, the DSADESTN.DAT file contains a record for each destination office, together with address details, laid out as follows:

FIELD	SIZE	TYPE	COMMENTS
Database Version ID	3	Numeric	1st digit represents version 2nd/3rd digit represents release
Destination Office ID	3	Numeric	Unique identifier for each Mail Centre
Destination Office Name	30	Alphabetic	Mail Centre Name
Address Line1	40	Alphabetic	1st line of the Mail Centre address
Address Line2	40	Alphabetic	2nd line of the Mail Centre address
Address Town	40	Alphabetic	Mail Centre Post Town
Postcode	8	Alphanumeric	Mail Centre Postcode
Total	204		Record Length

5.2 STEP 2: Format your labels

a. Where to position information on your labels:

- Figures 9 and 10 below show the dimensions of our bag and Tray labels. Both show the area for use by you to input your label information to assist you with your own routing of the Mailing Items

(**Customer Defined Information**) and the area of the label you must input information we require to help us route your Mailing Items (**Royal Mail Defined information**).

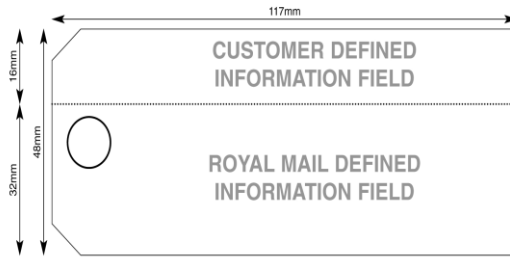

Figure 9: Bag label positioning guide

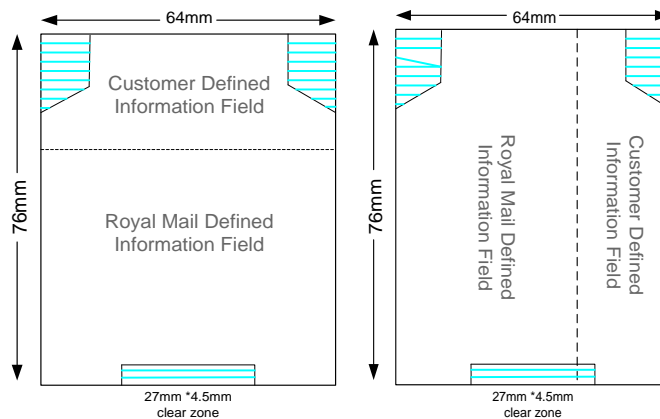

Figure 10: Tray label positioning guide

b. Seeking approval for your label design and Customer Defined Information:

- The Customer Defined Information field within the CFL is for your routing or other required information.
- The label design and any subsequent changes to the defined Customer Defined Information field require two months' prior written notice for approval from us before use. This is to avoid the potential for operational confusion. You must send hard copy proofs to your Access Account Director for approval prior to use.

c. Information you must include in the Royal Mail Defined Information field:

- The Royal Mail Defined information field is where you must include all the relevant information we require for you to route and handover the Container to the correct IMC.
- Figures 11 to 13 below are examples of what a Container label looks like, including the information to include, the specifications for field size, fonts and formatting. Please note all fields are aligned left, unless otherwise stated.
- Where you have entered into a separate ALPS optional schedule of the Contract, you must label each ALPS by securing the CFL to a blank York card, which is secured in the York label holder.

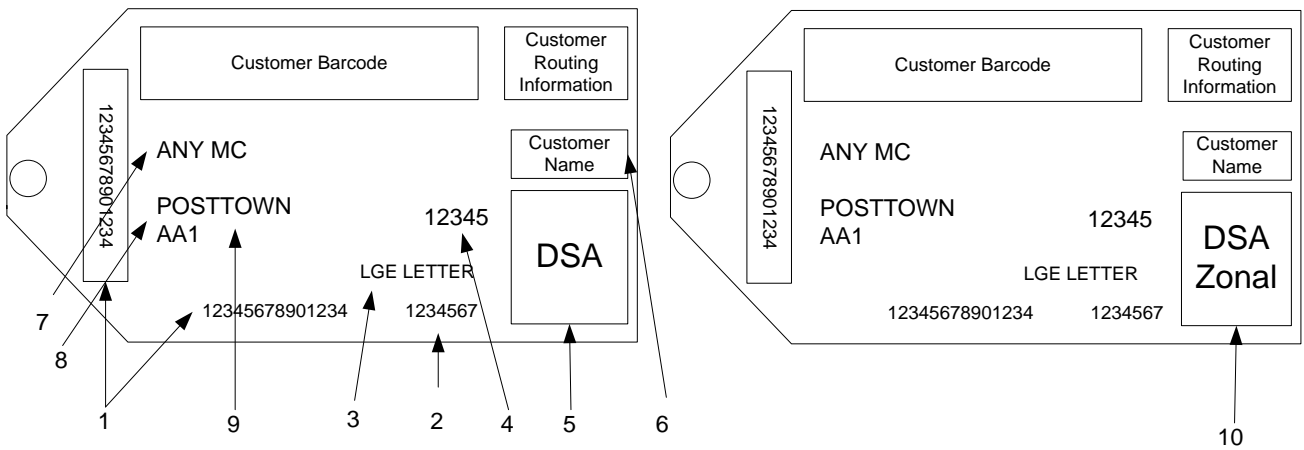

Figure 11: Bag label National (left label example) and Zonal options (right label example)

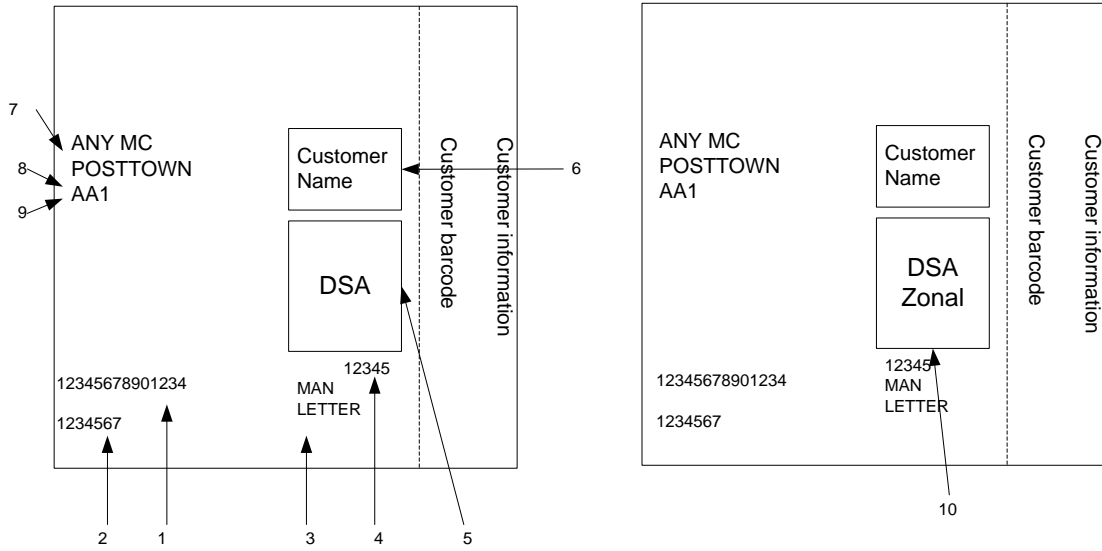

Figure 12: Vertical Tray label National (left label example) and Zonal options (right label example)

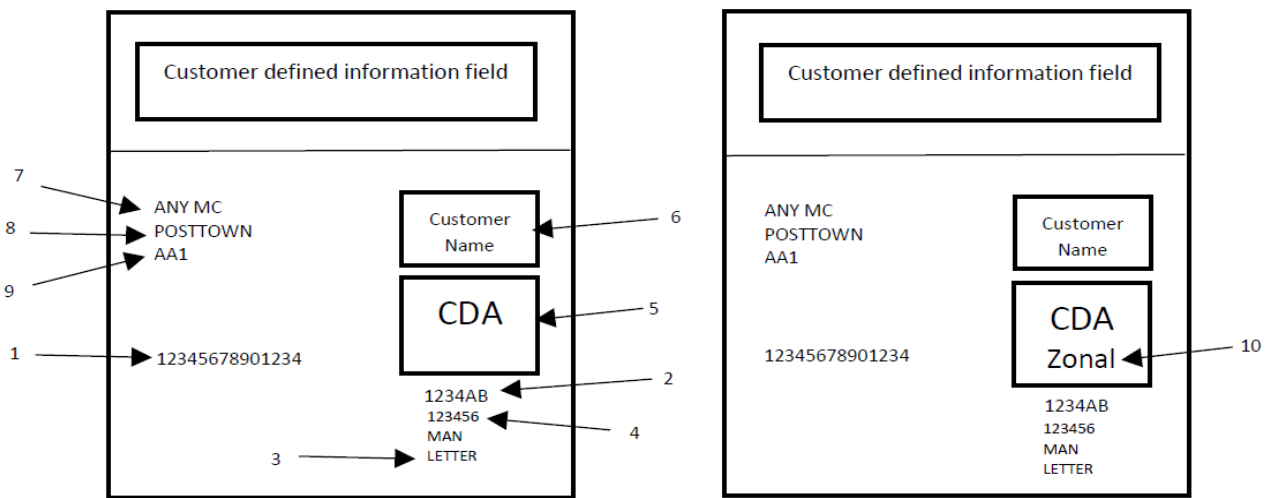

Figure 13: Horizontal Tray label National (left label example) and Zonal options (right label example)

- The below table provides further detail of what information against each of the label indicators in the above Figures 11 to 13, you are required to include on the labels:

LABEL INDICATOR NO.	ROYAL MAIL DEFINED INFORMATION	DETAILS	
1	Unique Container Identification Number	This is an identifying number unique to that Container (maximum of 14 characters). The same unique number is to be printed on the Manifest against the description of that Container's contents. It is optional whether you want to repeat the unique Container ID when using bags on the vertical axis as illustrated in Figure 11.	
2	Unique Customer Identification Number (UCID)	See Section 4.5(b) for more information about UCIDs and how you must use them.	
3	Format	This indicates whether there are Letters or Large Letters in the Container. Any references to Large Letters below includes General Large Letters. All formats shall be identified in the manner set out below and shall always be in uppercase:	
		Large Letters - Manual Item	LGE LTR
		Manual Letters	MAN LTR
		Mailmark Letters	MAILMARK
		Mailmark Large Letters	LL MAILMARK
4	Standard Selection Code (SSC)	The SSC as per the Access Selection Files.	
5	Customer type indicator (Optional)	This is optional - it indicates the type of customer you are: <ul style="list-style-type: none"> DSA for Access by operators (where you are the carrier for another operator who uses their own Contract, it is optional for 'DSA' to be followed by the last 3 digits of their Access Licence Number); CDA for customer direct access customers (CDA is then followed by the last 3 digits of your Access Licence Number); <p>Service Indicator</p> <p>In addition when any of the following Services are used it is a requirement to identify the service level achieved. This must be indicated above the Customer Type within the Customer Type Indicator box, using the correct abbreviation as stated below:</p>	
		Advertising Mail	ADVM
		Business Mail Large Letter	BMLL

		Magazine Subscription Mail	Mag Sub
6	Customer name	The name of the Customer or their Access Licence Number.	
7	Destination office	The destination office is the Inward Mail Centre at which the Container is to be handed over.	
8	Standard Selection Code description	<p>This field defines the Postcode group or plan number within the Container and this information can be obtained from the CFL database:</p> <ul style="list-style-type: none"> • For Manual and Manual Mailmark - this is the Postcode Area (or District) followed the by relevant Postcode grouping; • For Mailmark Letters – this is the word PLAN followed by the plan number, which relates to the Inward Mail Centre sorting plan the Container is going to. • For Mailmark Large Letters – this is the Postcode Area (or District) followed the by relevant Postcode grouping. 	
9	Zonal indicator	<p>The indicator 'ZONAL' must be included on the CFL. The recommended positioning is to place this Zonal Indicator to the right of the CFL.</p> <p>It is mandatory for the wording on the label to be clear and legible and a minimum point size of 10.</p>	

d. Labelling unbagged Mailing Items:

- Each bundle containing unbagged Mailing Items must be labelled as follows:
 1. unique bundle ID number;
 2. UCID number;
 3. Format;
 4. Customer name or Access Licence Number;
 5. Customer type;
 6. Destination office;

7. Standard Selection Code name;

8. Standard Selection Code description.

- For bundles held together with strapping, the label may comprise a simple carrier on top of the bundle and held in place by the strapping. You or your customer will provide these labels, which should be placed in the top right corner of the bundle and which may correspond to the dimensions of the items being posted, but must be at least 125mm x 176mm, and the text will be large enough to be highly visible (recommended 18 point or above).
- Where strappex has been used to hold the bundle together it is preferred that the Delivery Address is fully obscured on the top Mailing Item. This allows the bundle label to be applied through or across the strappex if desired.
- For bundles held together with polywrap, the label should comprise a white adhesive label, of comparable size to the normal bag label (12cm x 5cm), applied to the outside of the polywrap. The label should be applied in such a position that it obscures the Delivery Address of the Mailing Item beneath the wrapping to avoid the bundle being perceived as a single Mailing Item.
- Standard bag labels may only be used if they can be affixed securely to the top of the bundle and it can be assured that the label will remain on the top of the bundle during transport. (Attaching labels to the strapping with bag ties is NOT acceptable for Health and Safety reasons unless the loose end of the bag tie has been clipped.) It is not allowed to place loose labels under strapping.

e. Use the correct size and font specifications for the label information:

- The following table provides a guide as to the font size and relative font height of the CFL characteristics for bag labels:

CHARACTERISTIC	FONT SIZE (HELVETICA BOLD AND ARIAL BOLD ARE BOTH ACCEPTABLE AS FONT TYPES)	FONT HEIGHT	MAXIMUM NO OF CHARACTERS
Unique Bag Identification Number	11pt	3mm	14
Unique Originating Customer/Customer Identification Number	11pt	3mm	15
Format	13pt	4mm	15
Customer Name	11pt	3mm	
Customer Type indicator	28pt (DSA or AGY) 21pt (DSA/XXX or AGY/XXX) 21pt (CDA/XXX) 8pt ADVN min 8pt	12mm (DSA or AGY) 6mm DSA/XXX or AGY/XXX) 6mm (CDA/XXX) 3mm	(DSA or AGY) 3+3 DSA/XXX or AGY/XXX) 3+3 (CDA/XXX) 6
Destination Office	17pt	7mm	25
Standard Selection Code Name	14pt	5mm	25
Standard Selection Code	14pt	5mm	5
Standard Selection Code Description	14pt	5mm	14
Database Version Indicator (optional)	10pt Oriented 90 degrees	3mm	3
Zonal option Indicator (optional)	Minimum 10pt	3mm	5
Mixed Weight Identifier	17pt	7mm	2

- The following table provides a guide as to the font size and relative font height of the CFL characteristics for Tray labels:

CHARACTERISTIC	FONT SIZE (HELVETICA BOLD AND ARIAL BOLD ARE BOTH ACCEPTABLE AS FONT TYPES)	FONT HEIGHT	MAXIMUM NO OF CHARACTERS
Unique Tray Identification Number	10pt	3mm	14
Unique Originating Customer/Customer Identification Number	10pt	3mm	15
Format	12pt	4mm	15
Customer Name	8pt	3mm	
Customer Type Indicator	28pt (DSA or AGY) 18pt (DSA/XXX or AGY/XXX) 18pt (CDA/XXX) 8pt ADVM min 8pt	12mm DSA or AGY 6mm (DSA/XXX or AGY/XXX) 6 mm (CDA/XXX) 3mm	(DSA or AGY) 3+3 (DSA/XXX or AGY/XXX) 3+3 (CDA/XXX) 6
Destination Office	16pt	7mm	25
Standard Selection Code Name	14pt	5mm	25
Standard Selection Code	14pt	5mm	5
Standard Selection Code Description	14pt	5mm	14
Database Version Indicator (optional)	10pt Oriented 90 degrees	3mm	3
Zonal option Indicator (optional)	Minimum 10pt	3mm	5
Mixed Weight Identifier	16pt	7mm	2

5.3 STEP 3: Print your labels

a. Choose your label printing method:

- There are two methods you can use to carry out CFL:
 - Using label printers** - If you are a large business, the label printer (similar to those used in our sorting offices) is probably the most efficient option for carrying out CFL. You could use a label printer in one of the following two ways:
 - On Demand** - this allows you to generate your own labels according to your specific needs, by keying in the relevant SSC to your internal software;
 - Batch File Processing** – label printing machines can also be used in a batch processing mode by either, manually keying in label requirements in advance from a printed list or computer disk, or driving the printer directly from your computer system.

If this is the method you decide to use, you first need to decide whether to run the label printing machine on-line or off-line. This will depend on a number of factors:

- i. The number of production lines in use at any one time;
- ii. The type of mailing; and
- iii. The type of environment (both the computer and printer will operate more efficiently in a clean environment).

However, to operate the label printing machine off-line, in batch mode, you will first need to decide whether to key each batch of SSCs manually via an electronic process, or directly from your computer system.

2. **Database method** - we provide you with a label database containing the necessary geographic routing information to enable accurate labelling. You will, however, need to purchase or develop your own software to access this database.

There are two main areas you need to consider if implementing the database method:

- i. **Production process** - we will supply you with blank labels and plastic ties to tie your bags; and
 - ii. **Computer systems** - we will provide you with test data and implementation guidelines (available from your Access Account Director). You will then need to perform the programming required to provide access to the CFL database, and the capability of the printer to produce labels meeting our specifications.
- Once you have chosen the labelling method you want to use, the first thing to do is to contact your Access Account Director, who will help you to work out your specific requirements. If you choose the database method, you must also produce a set of test labels for us to validate before you can fully implement Access labelling.
 - Whichever method you choose, you should draft an appropriate contingency plan to implement in case the main system should fail.

b. Printing labels onto unbagged Mailing Items:

- Where you wish to print labels directly onto Mailing Items, or the top item of a bundle, the Mailing Items must be of the following sizes:
 1. Letters: minimum size of 229mm long, 165mm high and 1mm thick. i.e. C5 envelope format
 2. Large Letters: maximum size of 353mm x 250mm x 25mm thick.
- The label content must meet the standard labelling requirements set out at Section 5.2 above. The only difference from the standard requirements is that it is permitted to print the label details on the Mailing Item if unwrapped or the outer wrap of the item.
- A label outline border must not be printed around the label.
- A 5mm clear zone must be provided around the 'label area'. Consequently, an area of 128mm by 58mm is required for the label and its clear zone as illustrated in Figure 14 below:

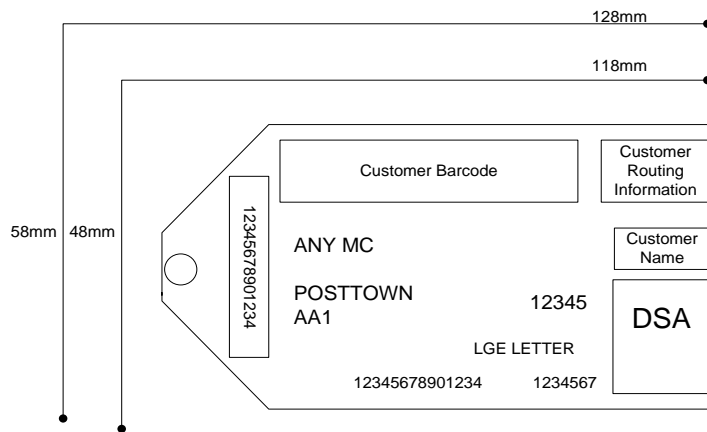

Figure 14: Label clear zones

- The label must be printed on a white background and in an area free from other printing.
- The label must be positioned above and to the left of the Delivery Address block. Where the return address is on the front of the Mailing Item, the label must be below the return address block, as illustrated in Figure 15:

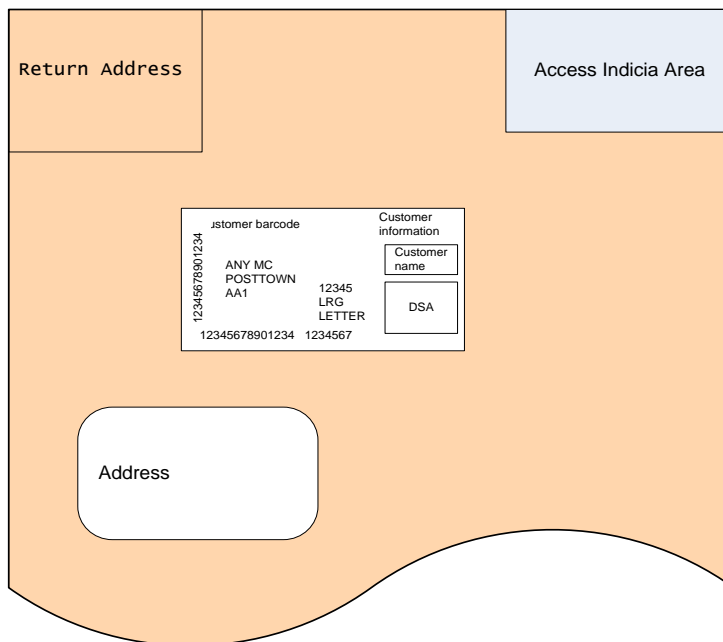

Figure 15: Return address positioning

- Where the bundles of a mailing are polywrapped, the current requirement to obscure the Delivery Address of the top Mailing Item with a carrier sheet/adhesive label over it remains. This is to ensure that the bundle is split before delivery and that all items do not go to a single address. However, where bundles have been strapped, it is not mandatory to cover the top Delivery Address providing that the above labelling requirements are met.
- It is preferred that only the Access Indicum, Delivery Address block, return address block and the label should be visible on the face of the Mailing Item but this is not a mandatory requirement.

6 Producing your documentation

You must give us the correct documentation with your Posting.

For Royal Mail Mailmark® postings you will need to also submit the documentation as specified in this section, and a Manifest for DocketHub will need to be uploaded. Please refer to Appendix M which provides further details about eManifests.

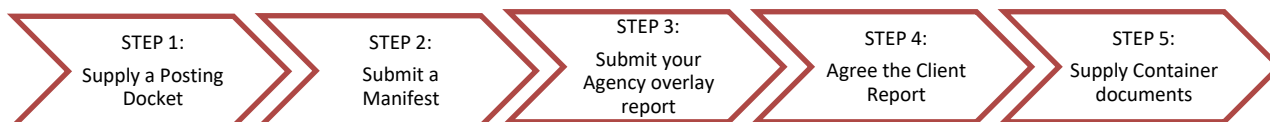

6.1 STEP 1: Supply a Posting Docket

a. What is a Posting Docket?

- The Posting Docket is used to calculate the Access Charges that will be invoiced to you and it must accurately record the Daily Posting.
- You must supply a Posting Docket in respect of each Daily Posting, unless you have agreed to and you meet the eligibility requirements set out in Schedule 8, Part 4: eManifest Billing of the Contract, in which case, instead of providing a Posting Docket, you may solely provide a Vehicle Manifest via DocketHUB and an eManifest. See Appendix Q for further details about the specification requirements when using eManifest Billing.

b. How to supply a Posting Docket to us:

- Posting Dockets and supporting data to enable the creation of Manifests must be submitted electronically to us using our DocketHUB system (or other system that we may develop and make available),
- The Posting Docket must be confirmed and received by DSACC on the Handover Day of the Mailing Items to which the Posting Docket refers, no later than:
 1. 06:00am if you are using an Earlier Access Slot (see Section 8.1(b) below); or
 2. 06:30am if you are only using Access Slots which start at 07:30 or later.
- Our [Web-services technical specifications](#) provides useful guidelines and detailed specifications as to how to use DocketHUB.

c. How DocketHUB calculates your Access Charges:

- The Posting Docket must represent the sum of the information provided in the Manifests relating to your Daily Posting. See Section 6.2 below to find out more about Manifests.
- DocketHUB will automatically calculate the indicative Access Charges for the Posting Docket, with the final values confirmed via our invoice to you. This is because DocketHUB holds the Access Charges to a different decimal place level to our invoicing system which creates small discrepancies due to rounding up.
- Where you are using an alternative system to DocketHUB, which we have approved, you shall calculate the Access Charges in accordance with the requirements of the Contract on the occasion of each Daily Posting and you shall provide full and accurate details of that calculation and Daily Posting in the Manifests in accordance with this User Guide.

d. Queries or issues relating to DocketHUB:

- If you require additional information relating to DocketHUB, please contact DSACC in the first instance.
- In the unlikely event that problems arise and you are unable to submit a Posting Docket electronically, then with the prior agreement of DSACC alternative arrangements for the submission of Posting Dockets and Manifests will be made.

6.2 STEP 2: Submit a Manifest

a. What is a Manifest?

- Please note: The Manifest is not to be confused with an eManifest. An eManifest is an electronic submission to eMHS for Mailmark postings only. An eManifest is a list of all the items for a Supply Chain and is uploaded each Working Day mail is handed to Royal Mail. Please refer to our eMHS Technical Specification, which you can find at www.royalmailwholesale.com/royal-mail-mailmark, for details.
- A Manifest is your declaration of the details of the Posting to be handed over by you to us at each Inward Mail Centre.
- The Manifest:
 1. allows us to verify that Mailing Items have been presented in accordance with your obligations under the Contract and that the Posting Docket's details reflect the Postings and/or Daily Posting; and
 2. provide confirmation that some Mailing Items were handed over to an Inward Mail Centre.
- The Manifest must accurately represent the contents of each Container and must contain the following information:
 1. Account name;
 2. Access site (Inward Mail Centre being accessed);
 3. Access site address;
 4. Handover date;
 5. Your account number;
 6. Your Posting Docket number;
 7. Your Access Licence Number;
 8. Details of each Container must be listed on a single line including:
 - i. A unique Container identification number that corresponds to the same number on the Container label;
 - ii. eManifest ID - only for when posting Mailmark Mailing Items;
 - iii. Supply Chain ID (SCID) – only for when posting Mailmark Mailing Items;
 - iv. A UCID – if relevant that corresponds to the same number on the CFL;
 - v. Standard Selection Code – the SSC within the current Access Selection File for the relevant selection;
 - vi. Postcode Area – the first alpha character(s) of the Postcode (i.e. G for Glasgow Postcodes);
 - vii. Product Code Details;
 - viii. Zone – if applicable to your Price Plan, list the number of Mailing Items by Zone in a Container;
 - ix. Number of Mailing Items in each Container - for National Price Plan One or Averaged Price Plan Two Postings populate in the "NAT" column;
 - x. Average Mailing Item weight;
 - xi. Total weight of Mailing Items – excluding the weight of the Container, label and bag tie;
 - xii. Declared Container weight;
 - xiii. Declared Container items.

Customer Name: _____

Site Manifest / Delivery Note

IMC: Inward Mail Centre _____ Date of Handover to Royal Mail: _____

IMC: _____ Account Number: _____

IMC Address: _____ Posting Docket: _____

_____ Licence Number _____

Job Ref: _____ Sheet: _____ of _____

Total Bags (Declarations + Exceptions)		Total Trays* (Declarations + Exceptions)		Total ALPS* (Declarations + Exceptions)	
1	Number of bags on the system upload	4	Number of trays on the system upload	7	Total number of ALPS on the system upload
2	Number of exceptions – bag removal from system upload	5	Number of exceptions – trays removal from system upload	8	Number of exceptions - ALPS removal from system upload
3	Number of exceptions – bag additions to system upload	6	Number of exceptions – tray additions to system upload	9	Number of exceptions - ALPS additions to system upload
	Total number of bags presented (Total =1-2+3)		Total number of trays presented 1 for 1 swaps (Total =4-5+6)		Total number of ALPS presented for 1 for 1 swaps (Total = 7-8+9)

Total Yorks*
(total handed over 1 for 1 swaps)

Total number of Yorks presented for 1 for 1 swaps	
---	--

*To be populated only when customer has signed appropriate Container Agreement.

hh

Customer use only:

Figure 17: Summary Manifest for a single customer

Carrier name: Inward Mail Centre				Handover date to Royal Mail: Sheet: _____ of: _____			
The following Postings are handed over today:							
Name of Contract Holder	Customer A	Customer B	Customer C				
Account Number							
Posting Docket:							
Licence number							
Total number of trays Including net effect of + and - exceptions							
Total number of bags Including net effect of + and - exceptions							
Total number of ALPS Including net effect of + and - exceptions							
Total number of bags, trays ALPS Including net effect of + and - exceptions							

This delivery note does not constitute acceptance that the above details are correct, as these detail will be subject to Royal Mail revenue protection and mails verification checks. For the avoidance of doubt this document only acknowledges the handover of Mailing Items on the time and date specified.

Signature of Royal Mail _____ For Royal Mail use only _____ Date of handover to Royal Mail _____

Please print name _____ Arrival time at Royal Mail _____

Signature Carrier _____ Customer use only: _____

Please print name _____

Figure 18: Summary Manifest for multiple customers

c. Procedure if you have signed up to Acceptance by Vehicle:

- If you have agreed to Schedule 5, Part 3: Acceptance By Vehicle of the Contract, in addition to the Manifest, you are required to each Working Day:
 1. accurately declare to us via DocketHub the number of vehicles due to arrive at each Inward Mail Centre for each Access Slot (**Vehicle Declaration**). For Access Slots prior to 09:00, you must upload your Vehicle Declaration no later than half an hour before your due Access Slot, and for Access Slots from 09:00 onwards, you must upload your Vehicle Declaration by 08:30.

If you fail to provide, or provide us with an inaccurate Vehicle Declaration, we may not be able to accept your vehicle(s). If it is operationally practical for us to do so, we shall accept the vehicle(s) but we reserve the right to charge you an administrative charge; and
 2. upload a Vehicle Manifest in to DocketHUB at least 30 minutes before your due Access Slot and provide two physical copies of the Summary Vehicle Manifest (see Figure 19) when you hand over the Mailing Items at an Inward Mail Centre. This Summary Vehicle Manifest is in place of the Summary Manifest.
- If you do not supply a Vehicle Manifest in line with the above, you must inform DSACC immediately. We shall refuse access to any vehicle that arrives at an Inward Mail Centre without having notified us in advance of its consignment by submitting a Vehicle Manifest.

Electronic Docket Submission Docket Adjustment – Agency Overlay		
Docket Number: Z12345678	Overlay date: dd/mm/yyyy	
Customer:	Account: 123456789	
Description	Items	Average Weight(g)
Customer (Agreement Type) (account)		
01 – IMC\70__\Lrg Ltr Advmail\Man Tray\ A	0	0
01 - IMC\70__\Lrg Ltr Advmail\Man Bags \ B	0	0
01 – IMC\70__\Lrg Ltr Advmail\Man Bags\ C	0	0
01 – IMC\70__\Letters Advmail\EIB Tray\ A	0	0
01 – IMC\70__\Letters Advmail\EIB Tray\ B	0	0
01 – IMC\70__\Letters Advmail\EIB Bags\ C	0	0
01 – IMC\70__\Letters\Man Bags\ A	0	0
01 – IMC\70__\Letters\Man Tray\ B	0	0
01 – IMC\70__\Letters\Man Bags\ C	0	0
Sub Total		
Customer (Agreement Type) (account)		
01 – IMC\70__\Lrg Ltr Advmail\Man Tray\ A	0	0
01 - IMC\70__\Lrg Ltr Advmail\Man Bags \ B	0	0
01 – IMC\70__\Lrg Ltr Advmail\Man Bags\ C	0	0
01 – IMC\70__\Letters Advmail\EIB Tray\ A	0	0
01 – IMC\70__\Letters Advmail\EIB Tray\ B	0	0
01 – IMC\70__\Letters Advmail\EIB Bags\ C	0	0
01 – IMC\70__\Letters\Man Bags\ A	0	0
01 – IMC\70__\Letters\Man Tray\ B	0	0
01 – IMC\70__\Letters\Man Bags\ C	0	0
Sub Total	0	0
Grand Total	0	0

Figure 201: Agency overlay report (National and Zonal accounts)

6.4 STEP 4: Agree the Client Report

a. What is the Client Report and how is it agreed?

- The Client Report enables us and you to agree the adjustments made to the Posting Docket.
- Each Working Day DSACC will generate an email message to inform you that your Client Report is available to view and to be agreed. The Posting Docket cannot be approved until agreement is received from you and you must do this promptly and in any case within 2 hours of receipt of the Client Report.
- The Client Report comprises of a summary report and other supporting information (e.g. Under Volume Containers and missorts).

6.5 STEP 5: Produce Container documents

a. Produce your waybill documentation when using Yorks or Trays:

- If you are handing over Mailing Items in Yorks or Trays you must provide a waybill to us.
- The waybill controls the volume of Containers you are using, and supports the one for one exchange of Containers in line with the relevant York or Tray optional schedule of the Contract. The driver

should ensure the waybill is complete before leaving the Inward Mail Centre and any issues reported to DSACC within 24-48 hours.

- Figure 21 provides an example of a waybill:

Downstream Access Container Waybill			
Customer Name			
Mail Centre Name :			
Container Type	Handover	Returned	Balance
Yorks (1)			
Trays			
Bags (2)			
<small>(1) Ensure Yorks used to return Trays or ALPS are included in York returned figure - should not exceed handover figure (2) For a UK Mail Red cage or TNT Magnum use an average fill of 250 bags</small>			
RM Name		Driver Name	
RM Signature		Driver Signature	
Date		Date	

Figure 21: Waybill

- If you have agreed to Schedule 5, Part 3: Acceptance By Vehicle of the Contract, you do not need to provide us with a separate waybill as it is incorporated in to your Summary Vehicle Manifest which you will provide a copy of when you hand over your Postings.

b. Displaying a York card when using Yorks:

- If you are handing over Mailing Items in Yorks, you must clearly and visibly display a York card on the York.
- The information contained within the York card enables the accurate and efficient handling of your Daily Posting.

- Figure 22 provides an example of a York card:

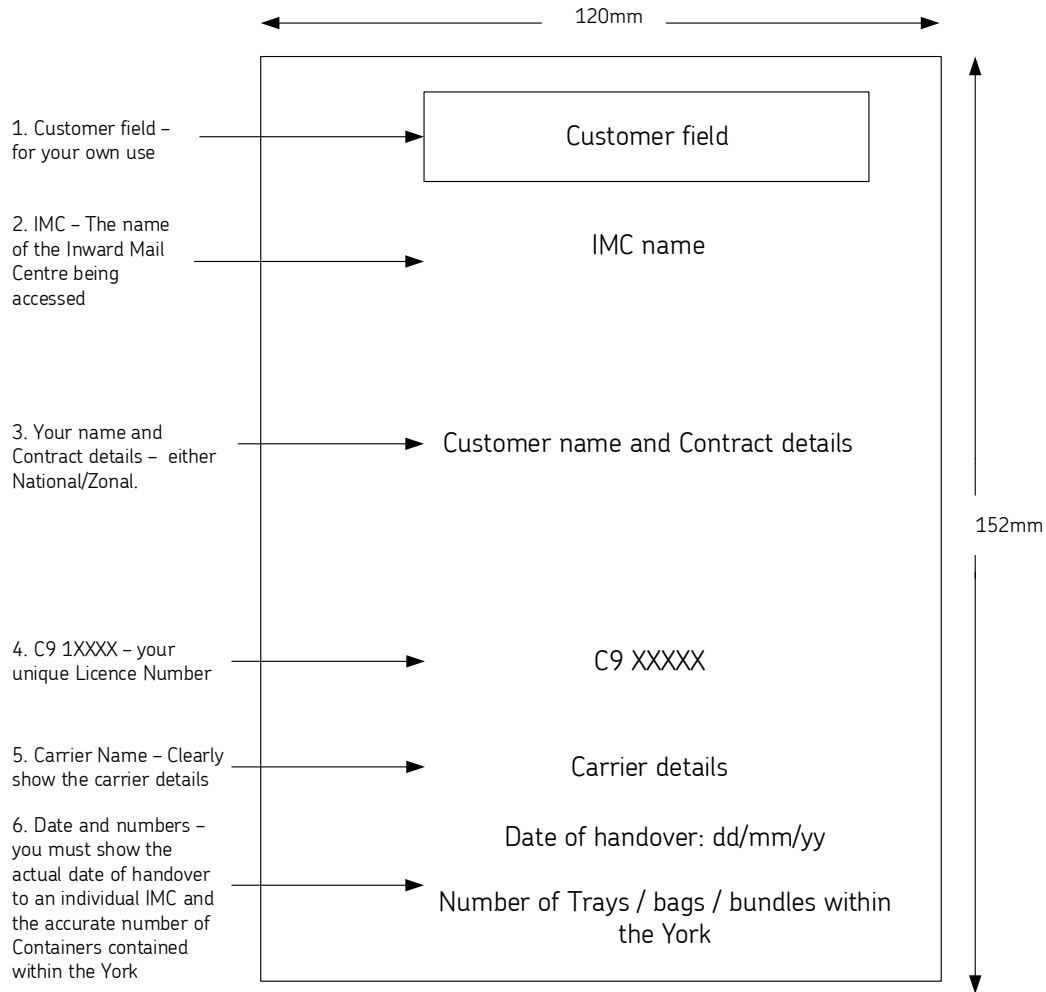

Figure 22: York card

- If you are using Segregation by Format (see Section 9.3(c)) it is necessary for each York to clearly and visibly display the following information on a York card:

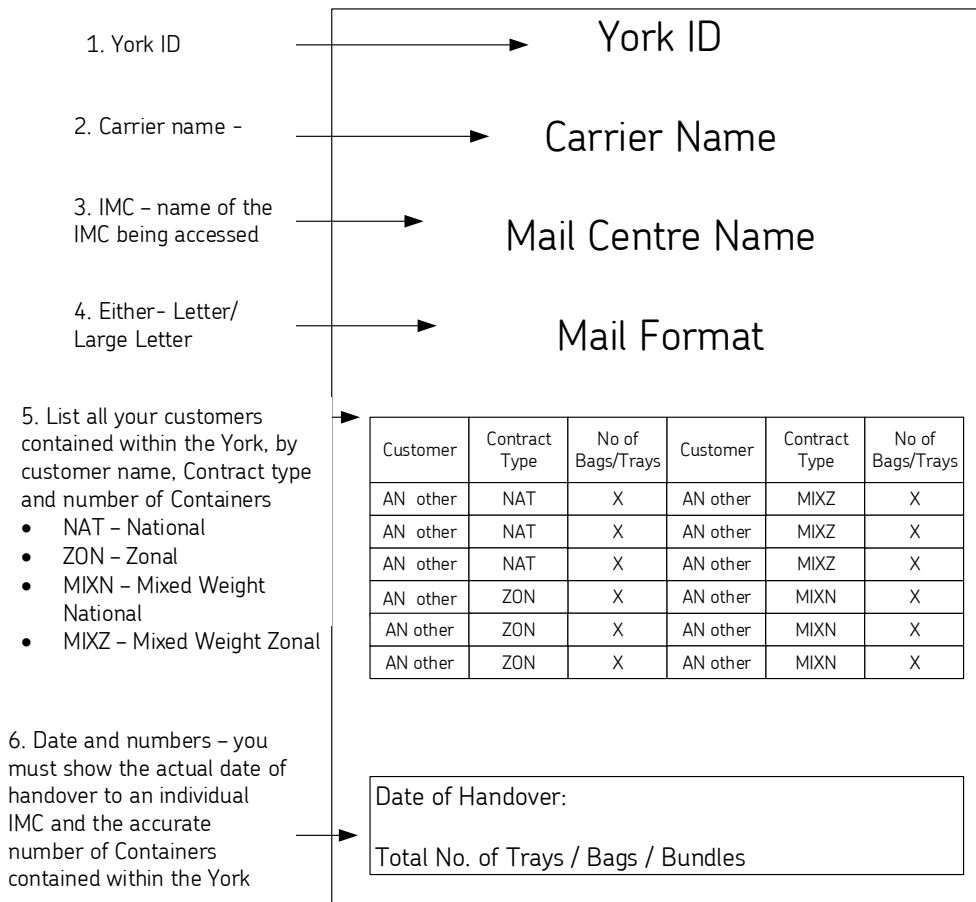

Figure 23: Segregation by Format York card

- If, on any Handover Day, you have more than 500 Containers to decant into Yorks at any one Inward Mail Centre, you must apply accurate York cards in the same way as if you were using Yorks to deliver, as set out in Figure 23 above (but only for those Inward Mail Centres where more than 500 Containers have been decanted).

c. Submitting York manifests:

- Unless you have agreed to Schedule 5, Part 3: Acceptance By Vehicle of the Contract, if you are using Segregation by Format (see Section 9.3(c)), you will be required to submit an accurate York Manifest electronically to us by no later than 08:00 on each Handover Day. If you are acting on behalf of other Customers, if you decant Containers into Yorks at Inward Mail Centres, you need only submit a York Manifest when you are handing over more than 500 Containers to any one Inward Mail Centre in any one day (and then only for those Inward Mail Centres where more than 500 Containers have been decanted).
- If you have uploaded Exceptions, creating a possible error to the York Manifest, a second and final accurate York Manifest must be sent electronically to us by no later than 10:15 on each Handover Day.
- Figure 24 illustrates the minimum information that is required on the York Manifest:

Mail Centre (DSADE STN)	UCID	Customer Name	Account Number	Contract Type	Format	York ID	No of Containers

Figure 24: York Manifest

- The York Manifest must be presented in a CSV file format, or such other format as specified by us from time to time.

7 Calculating your Postage

This section provides an overview for the process for calculating the Postage for your Postings.

7.1 Postage for Mailing Items with a constant price (0-100g and 101-250g):

- a. For Letters and Large Letters which are in the 0-100g and 101-250g weight bands, the Postage is calculated by multiplying the total number of such Mailing Items by the relevant per Mailing Item Access Charge according to the Format and Service.

7.2 Postage for Mailing Items in weight bands using a pricing formula (251-750g):

- a. For Large Letters which are in the 251-750g weight bands, the Postage is calculated by using the following steps:
 1. Calculate the average weight per Large Letter using the following formula:

$$\frac{\text{Total weight of Large Letters}}{\text{Total number of Large Letters}} = \text{Average Weight}$$

2. Calculate the per Mailing Item Access Charge by using the relevant pricing formula for the average weight step for the Service.
3. The Postage for such Mailing Items are calculated by multiplying the per Mailing Item Access Charge by the total number of Large Letters.

8 Procedures before you handover mail

To assist us with our operational planning and to ensure we are fully prepared to accept the handover of your Postings and to meet the Service Standard, there are certain procedures and tasks you must complete before your date of handover.



If you are posting a Key National Posting (KNP) please refer to Appendix B, which provides guidance on the forecasting requirements for KNPs.

8.1 STEP 1: Book your Access Slots

a. What is an Access Slot?

- Postings must be handed over at Inward Mail Centres during the Access Window.
- You must book an Access Slot for handover of Mailing Items at each Inward Mail Centre. The Access Slot is a 30-minute time period within the Access Window, during which you must begin handover. You must use reasonable endeavours to complete unloading your vehicle within 30 minutes of the time at which you began. We may refuse to accept Mailing Items if you do not begin hand over during your Access Slot or if you have not used reasonable efforts to complete hand over within a reasonable period of time. The table below shows the Access Slots which you can choose from at each Inward Mail Centre if they are available.
- Some Earlier Access Mail Centres offer Access Slots from 06:30 to 12:00 but some Earlier Access Mail Centres only offer Access Slots from 07:00 to 12:00. All other Inward Mail Centres offer Access Slots from 07:30 to 12:00.

Access Slots	Access Slots	Access Slots
06:30 – 07:00*	09:00 – 09:30	11:30 – 12:00
06:45 – 07:15*	09:15 – 09:45	
07:00 – 07:30**	09:30 – 10:00	
07:15 – 07:45**	09:45 – 10:15	
07:30 – 08:00	10:00 – 10:30	
07:45 – 08:15	10:15 – 10:45	
08:00 – 08:30	10:30 – 11:00	
08:15 – 08:45	10:45 – 11:15	
08:30 – 09:00	11:00 – 11:30	
08:45 – 09:15	11:15 – 11:45	

*Only applicable to Earlier Access Mail Centres with an Earlier Access Window between 06:30 and 07:30.

**Only applicable to Earlier Access Mail Centres with an Earlier Access Window between 06:30 and 07:30 or between 07:00 and 07:30.

b. Earlier Access Slots:

- If we allocate you an Earlier Access Slot, then:
 1. if you have agreed to Schedule 5, Part 3: Acceptance by Vehicle of the Contract, you must either:
 - a. replace a pre-10:00am Access Slot, which you have already been allocated at an Earlier Access Mail Centre, with the Earlier Access Slot; or

b. replace your post-10:00am Access Slot with the Earlier Access Slot; and

2. in all other cases, the Earlier Access Slot will be instead of, and will replace, any Access Slot which you have previously been allocated under the Contract at the relevant Earlier Access Mail Centre.

c. Access Slot change request process:

- The aim of this process is to ensure that requests for new or changes to existing Access Slots are managed in a controlled way.
- Within three months of your Access Start Date we will consider reasonable requests to change your Access Slots. After this initial period you may request a change to the timing of your Access Slots up to 4 times per Inward Mail Centre per annum. DSACC will either confirm in writing that the Access Slot is available, or if it is not, offer an alternative where available. Whilst we will use reasonable efforts to meet your requirements, this may not be possible in every instance. The final decision regarding the allocation of Access Slots rests with us.
- Any requests for changes to Access Slots must be made via DocketHUB and we may require at least 14 Working Days for change requests to be processed.
- You must use your existing Access Slot until such time as we have confirmed any Access Slot changes in writing.
- In instances of Inward Mail Centre consolidation, we will use reasonable efforts to continue to meet your requirements at the Inward Mail Centre affected by the change but may require you to change your Access Slot or, in cases of multi vehicle use, to accept more than one Access Slot.

d. Using multiple vehicles per Access Slot on a regular basis

- *If you have agreed to Schedule 5, Part 3: Acceptance by Vehicle of the Contract, you should follow the process requirements set out in this section in addition to complying with the requirements set out in Schedule 5, Part 3: Acceptance by Vehicle.*
- *The Acceptance by Vehicle process involves a Carrier who uses or shall use more than one vehicle in one Access Slot to handover Mailing Items to an Inward Mail Centre, and intends to use two Access Slots (Dual Slots) or three Access Slots (Tri Slots) handover Mailing Items to an Inward Mail Centre. For clarity, the term "one vehicle" includes double decker vehicles and draw-bar vehicles.*
- *You agree to book with us, acting reasonably, and use:*
 1. *in respect of Dual Slot Mail Centres, at least (i) one Early Access Slot; or (ii) if the Dual Slot Mail Centre is an Earlier Access Mail Centre, one Early Access Slot or one Earlier Access Slot; and*
 2. *in respect of Tri-Slot Mail Centres, at least (i) two Early Access Slots; or (ii) if the Tri-Slot Mail Centre is an Earlier Access Mail Centre, two Early Access Slots, or two Earlier Access Slots, or one Early Access Slot and one Earlier Access Slot,*

*at those Multiple Slot Mail Centres where the daily volume of Mailing Items you hand over regularly requires you to use more than one vehicle in one Access Slot. An **Early Access Slot** is an Access Slot between 07:30 and 10:00 on any Working Day. As mentioned above, some **Earlier Access Mail Centres** offer Access Slots from 06:30 to 12:00 but some Earlier Access Mail Centres only offer Access Slots from 07:00 to 12:00.*

- *You agree that, over each Contract Year, on average a minimum of 50% of your annual volume of Mailing Items due for hand over at each Multiple Slot Mail Centres shall be handed over in your Early Access Slots and/or Earlier Access Slots (as applicable) at each of those Multiple Slot Mail Centres.*

- See Section 6.1(c) of this User Guide in regards to Vehicle Declaration and Vehicle Manifest requirements when using Acceptance by Vehicle, and note the time for submitting a Vehicle Declaration when you are using an Earlier Access Slot.
- If you have uploaded a Vehicle Manifest but the vehicle fails to arrive during the Access Slot, you must inform DSACC immediately. DSACC shall decide whether the vehicle will be cancelled or may have later access to the Inward Mail Centre. If the vehicle is cancelled, you must confirm to us the identity of the vehicle to be cancelled so that the correct Vehicle Manifest is cancelled.
- See Section 9.3(a) of this User Guide for more information about what your driver is required to do when he or she arrives at the Inward Mail Centre and Acceptance by Vehicle is being used.
- If you wish to stop using an **Early Access Slot** or an Earlier Access Slot at a Tri-Slot Mail Centre you shall formally notify us on at least 60 days' written notice, except where we have given notice in line with clause 13.3(b) of the Contract which affects a Tri-Slot Mail Centre, in which case you may have 2 Working Days after the date of such notice to give us notice to stop using the Early Access Slot or Earlier Access Slot (as applicable) at that Tri-Slot Mail Centre and the effective date of your notice and ours will coincide. Should we subsequently change the effective date of our notice given in line with clause 13.3(b), you shall also be able to change the effective date of your notice to stop using the Early Access Slot or Earlier Access Slot (as applicable), such that the effective dates still coincide. At the end of this notice period, you will revert to two booked Access Slots at the former Tri-Slot Mail Centre, making it a Dual Slot Mail Centre. If you wish to stop using all Early Access Slots and Earlier Access Slots (as applicable) at a Tri-Slot Mail Centre then the following point shall apply.
- If you wish to stop using **all Early Access Slots and Earlier Access Slots** at a Multiple Slot Mail Centre you shall formally notify us on at least 60 days' written notice, except where we have given notice in line with clause 13.3(b) of the Contract which affects a Multiple Slot Mail Centre, in which case you may have 2 Working Days after the date of such notice to give us notice to stop using the Early Access Slots and Earlier Access Slots at that Multiple Slot Mail Centre and the effective date of your notice and ours will coincide. Should we subsequently change the effective date of our notice given in line with clause 13.3(b), you shall also be able to change the effective date of your notice to stop using the Early Access Slots and Earlier Access Slots, such that the effective dates still coincide. At the end of this notice period, you will revert to one booked Access Slot at the former Multiple Slot Mail Centre.

e. Using multiple vehicles per Access Slot on an ad hoc basis

- If, on an ad hoc basis, you need to use more than one vehicle to bring in your Posting in your pre-booked Access Slot, due to volume of Mailing Items, you must notify DSACC at least 2 Working Days in advance by emailing DSACC@royalmail.com. The email must state the number of vehicles you intend to use.
- If you need to use double deck trailers, you must notify DSACC and get their agreement before their use is permitted. Not all Inward Mail Centres can accommodate double deck trailers.

f. Ad-hoc and additional Access Slot booking process:

- For Inward Mail Centres that you do not regularly access, you may book an ad-hoc Access Slot via DocketHUB. An ad-hoc Access Slot is an Access Slot which is only required for a limited period at

any Inward Mail Centre. Similarly, you may book additional slots at particular Inward Mail Centres should volumes warrant.

- Ad-hoc or additional Access Slots will be booked on a 'first come first served' basis. We may refuse your request, if for reasons of operational capacity or capability, we are unable to accommodate such an ad-hoc Access Slot request.
- The process for booking ad-hoc or additional Access Slots is as follows:
- You must provide at least 10 Working Days' notice to book an Access Slot for an Inward Mail Centre which you have not previously accessed.
- You must provide at least 2 Working Days' notice to book an Access Slot for an Inward Mail Centre which you have previously accessed.
- 2 Working Days before the required Access Slot, you must notify a request to DSACC by emailing DSACC@royalmail.com and booking the Access Slot via DocketHUB and following up with a back-up telephone call to DSACC, before 12:00. At the time of this telephone notification, you must also provide details of the driver and vehicle. You must specify the lifespan for the ad-hoc or additional Access Slot from one day up to a maximum of 1 calendar month period.

Please note, once the lifespan of the Access Slot has elapsed the Access Slot will be released for other Customers to use we reserve the right to withdraw the Ad-hoc facility and raise any reasonable charges if we believe you are misusing the facility.

- You must:
 1. provide 1-day forecasts in accordance with Section 8.3 below;
 2. provide documentation in accordance with Section 6; and
 3. order your Containers and consumables in accordance with Section 5.
- You should also provide a 7-Working Day rolling forecast in accordance with Section 8.2 below.
- Please note, the facility to book ad-hoc or additional Access Slots is not available when you are posting Key National Postings as detailed at Appendix B.

8.2 STEP 2: Submit 7-Working Day rolling forecast

a. Submit your 7-Working Day rolling forecast to DSACC:

- By 10:00 on each Working Day, you must provide DSACC with a daily rolling forecast of your posting intentions over the following 7 days via DocketHUB.
- Each Working Day's forecast will include your anticipated volume of Mailing Items for handover at each Inward Mail Centre, using reasonable efforts to provide a breakdown of volume by Format, and by processing option – Mailmark or Manual Item (including Manual Mailmark).
- If you do not intend to handover Mailing Items each Working Day then you must populate the rolling forecast on the relevant day(s) with '0'.
- Please note, if you are posting Key National Postings see Appendix B for the notification requirements.

8.3 STEP 3: Submit a 1-day forecast

a. Submit your 1-day forecast to DSACC:

- By 10:00 on each Working Day, you must provide DSACC with a forecast of the Daily Postings you intend to hand over on the next Working Day.
- The forecast must detail, as accurately as possible, the volume of Mailing Items by Format, and by processing option (i.e. Mailmark or Manual Item) that you expect to hand over to each Inward Mail Centre on the following Working Day.
- For those customers who have developed processes that generate a more accurate version of the forecast, you may provide us with an additional forecast by no later than 16:00 each Working Day of the Postings you intend to hand over on the next Working Day. For clarity, any reforecast you provide us by 16:00 will be accepted as fulfilling the contractual requirement that you provide us a forecast before Handover Day. Where you provide us with reforecast, we shall measure and use the accuracy of this later forecast for performance measurement purposes against the contract requirement for accuracy. Where no later reforecast is supplied, accuracy will continue to be measured using the 10:00 submitted forecast.
- You must inform us on the Working Day before the Handover Day if you wish to cancel a Posting.
- Please note, if you are posting Key National Postings see Appendix B for the notification requirements.

8.4 STEP 4: Submit your Posting Docket and Manifest

a. Submit your Posting Docket and Manifest to DSACC:

- You must provide DSACC a Posting Docket and Manifest in accordance with Section 6.1 and 6.2.
- For Royal Mail Mailmark® postings you will need to also submit the paperwork as specified in this section, and an eManifest will need to be uploaded to the eManifest Handling System (eMHS). Please refer to Appendix M which provides further details about eManifests.
- If you have agreed to and you meet the eligibility requirements set out in Schedule 8, Part 4: eManifest Billing of the Contract, instead of providing a Posting Docket, you may solely provide a Vehicle Manifest via DocketHUB and an eManifest. See Appendix Q for further details about the specification requirements when using eManifest Billing.

b. Submit your eManifest

- If you are mailing Mailmark items, you do need to upload an accurate eManifest per SCID per handover date (see Appendix M).

9 Handing over your Postings

It is very important that your representatives attending our Inward Mail Centres to handover your Postings do so in a safe and secure manner. This section sets out our requirements for adhering to our security and health and safety procedures.

9.1 Security procedures

a. Provide us with driver names and vehicle registrations:

- Using DocketHUB, you must supply DSACC with an up-to-date list of all driver names and vehicle registrations that will visit each Inward Mail Centre.
- You may only provide a maximum of 15 driver names and 15 vehicles per Inward Mail Centre in order to manage volumes going forward.
- You must ensure that any changes to the list (names, vehicles and effective dates) are actioned through DocketHUB no less than 48 hours in advance of the change coming into effect. As a contingency, we will allow access to an Inward Mail Centre for a non-listed driver and/or vehicle subject to you providing DSACC with at least one hour's prior notification via the letter of authorisation process in DocketHub . Your driver must carry a letter of authority in a format agreed by us to verify their details.
- We will refuse access to any driver or vehicle whose details do not appear on the list, unless contingency arrangements have been agreed by DSACC.

9.2 Health and safety

a. Compliance with our health and safety requirements:

- Prior to your first handover of Mailing Items, you will need to inform us of the appropriate escalation levels within your organisation for handling any health and safety issues.
- We have [general site health and safety requirements](#) which you must ensure your employees and agents comply with. You will also be required to ensure that all your employees and agents comply with any site-specific health and safety requirements. Wherever possible we will provide reasonable notification of changes to security procedures.
- When transporting, loading and unloading the Containers, you must only use vehicles that meet our reasonable requirements regarding:
 1. health and safety of personnel; and
 2. care of the Containers.
- All drivers must follow any health and safety instruction given by any of our employees.
- As a minimum, we will require all drivers to wear toe-protecting safety shoes and high visibility jackets whilst on our premises.
- All drivers must also comply with all our on-site traffic rules.
- All drivers will only have access to the areas of the Inward Mail Centre directly related to the handover of Mailing Items. Drivers must not enter any other areas (e.g. sorting hall).
- Any abusive or threatening behaviour (physical or verbal) towards any member of our staff will not be tolerated and access will be refused.

9.3 Procedures whilst on site

a. Driver arrival at Inward Mail Centres:

- On arrival at the Inward Mail Centre, we will check the driver's identity badge (which must carry a photograph) and vehicle registration against the list supplied by you. You or your carrier will be required to provide an example of their photographic identity badge (or that of a chosen third party carrier) to DSACC in electronic format.
- If you have agreed to Schedule 5, Part 3: Acceptance by Vehicle of the Contract, each of your vehicles must bear a unique vehicle identifier that correlates to the Vehicle Manifest (see Section 6.2(c)) specific to that vehicle and which must be visible and legible to us on arrival at the Inward Mail Centre. Any such vehicle identification methodology that does not use vehicle registration number plates must be agreed in writing by us prior to use.

b. Allocating your driver to a dock:

- On arrival at the Inward Mail Centre, one of our employees will direct the driver to the appropriate unloading dock. If the dock area is busy, our employees will ask the driver to wait until the dock has been cleared before the vehicle is unloaded.

c. Unloading and handover:

- Each Posting is independent of any other Posting.
- Where you hand over Postings on behalf of other customers, the Postings must not be mixed and segregation of different Postings must be maintained, unless you are Segregating by Format (see point below). Each Posting must be clearly identified by indicating whether it is being posted against your national account or a zonal account on the York Card (if a York Schedule has been signed).
- If you are acting on behalf of other Access customers, who have a contract with Royal Mail Wholesale, when you present Mailing Items to us on behalf of those other customers separately by each individual customer's Posting, you may combine these discrete individual customers' Postings together into Yorks, as long as each York only contains Mailing Items of the same Format. This is known as **Segregation by Format**. The exception to this is when you are using ALPS containers as part of your Contract. The contents of an ALPS container must remain discrete to the individual customer who holds a contract with us and must not contain Mailing Items pertaining to another customer who holds a contract with us.
- Your driver must unload the Posting into Containers when and where directed by our employees. Where you use Yorks, your driver is responsible for unloading/reloading the Yorks when and where directed by our employees.
- Where you hand over Postings on behalf of other Customers and hand over Containers in Yorks and you wish to amalgamate Containers from different Postings in the same York, you may do so provided:
 1. they are presented in accordance with the requirements of this section, and for the avoidance of doubt, if you are Segregating by Format you must carry out the separation of Containers by Format into those Yorks;
 2. each such York has an attached York card specifying the number of Containers by Customer in each York; and
 3. you undertake all reasonable efforts to ensure that the Containers pertaining to each Customer combined in a single York are not unnecessarily mixed e.g. segregation by a layer of cardboard or some other effective means.
- For information on unloading a KNP please see Appendix B.
- Unless you are using eManifest Billing (see Appendix Q), all Postings handed over at an Inward Mail Centre must be accompanied by two hard copies of the Manifest. (Due to the amount of paper used for the printing of a full Manifest it is preferable to use a Summary Manifest format

for this purpose.) These Manifests must not be placed inside Containers. At handover, your driver and one of our employees will sign, time and date both copies of the Manifest. Note that this procedure does not represent acceptance of the Posting in terms of volume, formats, or contents; it simply acknowledges that a quantity of items has been handed over. We and your driver will each retain one copy of the Manifest.

Alternatively, if you have agreed to Schedule 5, Part 3: Acceptance by Vehicle of the Contract when a vehicle arrives at an Inward Mail Centre, your driver must carry two copies of a Summary Vehicle Manifest. The Summary Vehicle Manifest shall be used in place of the "Summary Manifest" referred to in Section 6.2(b) of the User Guide and the waybill as referred to in Section 6.5(a) of the User Guide. Two copies of the Summary Vehicle Manifest will be signed, timed and dated by one of our employees after the vehicle is unloaded. One copy will be retained by your driver as a delivery note, and the other by the Inward Mail Centre. For clarity, the handover of Mailing Items and the signing of the Summary Vehicle Manifest shall not constitute our acceptance of the Mailing Items. Our acceptance of a Posting only occurs after we carry out Revenue Protection checks and any issues have been resolved with you to our satisfaction.

d. Exiting the Inward Mail Centre:

- Once the vehicle has been unloaded by your driver, your driver must move the vehicle away from the dock as soon as practicable (whilst observing the speed limit) and leave the site as directed by our employees.

e. Contingency:

- In the event of an Inward Mail Centre being inaccessible for any reason, our contingency plans will apply. DSACC will notify you of alternative arrangements and any subsequent change or reversion to normal practice as soon as is practicable.

10 Handling non-compliant Mailing Items and Postings

The Contract permits us to sample your Mailing Items upon receipt to check that they comply with the terms of the Contract and that your Postage declaration is accurate.

This Section 10 sets out the corrective action we will take against different non-compliance events relating to your Mailing Items, Daily Postings or procedures you are required to follow as set out in the Contract, including the User Guide.

Non-compliances relating to UCID Postings versus Consolidated Postings

If you have correctly used a UCID and the non-compliance relates only to that UCID Posting, the actions will only be taken in respect of that UCID Posting. If the non-compliance relates to a Consolidated Posting (i.e. to any part of a Posting which is not a UCID Posting) our actions may be taken in respect of the whole of that Consolidated Posting.

In this table we use the term "relevant segment" to mean that part of the Posting or Posting as the case may be (i.e. UCID Posting or Consolidated Posting to which the non-compliance relates).

If you do not use UCIDs, Mailing Items of the same Format and Access Service will be treated as a Consolidated Posting, and the term 'relevant segment' in this section will mean all Containers relating to the same Format and Access Service in the Daily Posting which do not bear a UCID.

In this section, reference to Containers shall apply to bundles presented as per the unbagged specification in Section 4.3(e) of this User Guide.

Action we may take in respect of rejected Mailing Items

As you will see within the table below, one of the remedial actions we can take in the event of a non-compliance event occurring, is to reject the Mailing Items, Posting or segments of Posting. Where the table makes reference to our ability to reject the Mailing Items, Posting or segments of the Posting, we will notify you of the decision to reject and:

- a. make the relevant Mailing Items available for your collection, for which we may charge you reasonable handling charges;
- b. if you have not collected the relevant Mailing Items on the Working Day following the Working Day you receive our notice under this paragraph we may charge you reasonable storage charges; and
- c. if you have not collected the relevant Mailing Items within 5 Working Days of such notification, we may dispose of the Containers and destroy those Mailing Items and charge you a reasonable amount for doing so.

Mailmark Adjustments

If you choose to use our Mailmark option, our [Mailmark Adjustments Explained document](#) provides a breakdown of the Mailmark Adjustments and how we apply them to different non-compliance events.

Enquiries & Complaints

Should we receive enquiries/complaints from recipients of Mailing Items (the addressee) sent under your Contract, the addressee will be advised to contact the originating sender (except where the issue concerns delivery procedures e.g. mis-delivery when we will deal directly with the recipient).

Should we receive enquiries/complaints from the Originating Customer of Mailing Items sent under your Contract, the Originating Customer will be advised to contact you.

Any issue that you wish to discuss in relation to your Contract should be raised in the first instance with your Account Director, unless otherwise specified in the Contract. Any complaint about service or operational issues should be raised in the first instance with DSACC by emailing DSACC@royalmail.com.

10.1 The basics and preparing your physical Mailing Items

Sections 2 and 3 of this User Guide sets out the requirements for the physical attributes of your Mailing Items, including meeting the Service specifications, complying with our addressing standards, applying Indicium, and segregating mailing items by processing option, Format and weight.

This Section 10.1 sets out the remedial action we may take in the event you do not comply with the requirements set out at Sections 2 and/or 3.

10.1.1 Addressing standards

Non-compliance event	Remedial actions
a. Mailing Items, that are posted as Manual Items, and that fail to meet the addressing standards as specified in Section 2, Section 3 and Appendix A of the User Guide.	We may reject the Posting or relevant segment of the Posting. Or, if it is a Zonal Posting, provided you have handed over the Posting at the correct Inward Mail Centre and if we agree it is operationally feasible to process, you will be charged the prevailing Access Zone C rate relevant to the Mailing Items, unless the Mailing Items are for delivery to the London Zone in which case you will be charged the prevailing Zone D rate relevant to the Posting or relevant segment of the Posting affected.
b. Mailmark Mailing Items that fail to meet the minimum level of address, Postcode and DPS accuracy standards as specified in Appendix M of this User Guide.	We may: <ol style="list-style-type: none">1. reject the Mailmark Mailing Items; or2. apply the applicable Mailmark Adjustment.
c. Manual Mailmark Mailing Items that fail to meet the minimum level of address and Postcode accuracy standards as specified in Appendix M of this User Guide.	We may: <ol style="list-style-type: none">1. reject the Manual Mailmark Mailing Items; or2. apply the applicable Mailmark Adjustment.

<p>d. Mailing Items do not bear a UK return address as specified in Section 3.3 of this User Guide.</p>	<p>We may reject the Posting or relevant segment of the Posting.</p> <p>Where a Posting or relevant segment of a Posting is found, after acceptance, to contain Mailing Items that do not bear a UK return address, if any such Mailing Items were to be returned to us as undeliverable or not wanted, we are not obligated to return such Mailing Items to you. We may dispose of those Mailing Items that have been returned to us and levy a charge to cover the reasonable costs of handling.</p>
<p>10.1.2 Sortation</p>	
<p>Non-compliance event</p>	<p>Remedial actions</p>
<p>a. Mailing Items are declared as the incorrect sortation level actually used to hand over those Mailing Items as specified in Section 2.3 of this User Guide (for example, Large Letter Mailing Items are declared as Access 70 but actually sorted as 48-way).</p>	<p>We may:</p> <ol style="list-style-type: none"> 1. reject that Posting or relevant segment of the Posting; or 2. if we believe it is reasonably practicable for us to do so, we will process the Posting or relevant segment of the Posting. In this case we will revert the Mailing Items to the correct Postage by amending the Posting Docket to reflect that all Mailing Items will be charged at the applicable Access Service and sortation level to which they have been sorted. Where we have statistically significant evidence that the error declared on the Manifest represents an error across all relevant segments, then we may amend the Postings based upon the statistically significant evidence.
<p>b. Mailing Items are not sorted using the current Access Selection Files Version or Access Selection Files Release as specified in Section 2.3 of this User Guide.</p>	<p>We may:</p> <ol style="list-style-type: none"> 1. reject that Posting or relevant segment of the Posting; or 2. if a current Access Selection File Version has not been used, and it is reasonably practicable for us to do so, we will process the Posting or relevant segment of the Posting. In this case we will revert the Mailing Items to the correct Postage by amending the Posting Docket to reflect that the affected Posting will be charged at the prevailing Access Zone C rate unless the Posting is for delivery to the London Zone in which case you will be charged the prevailing Zone D rate. Where we have statistically significant evidence that the error declared on the Manifest represents an error across all relevant segments, then we may amend the Posting based upon the statistically significant evidence; 3. if a current Access Selection File Version Release has not been used, and it is reasonably practicable for us to do so, we will process the Posting or relevant segment of the Posting(s). Where we have evidence that the Zonal Mailing Items handed over have been incorrectly declared to the current Access Selection File Version Release, we will revert the Mailing Items to the correct Postage by amending the Posting Docket to reflect the correct Zone for those Mailing Items identified and the relevant Zonal charges will apply. Where we have evidence that Zonal Mailing Items handed over have been incorrectly declared to the new Access Selection File Version Release 14 or more days after the current Access Selection File Version Release date has come into effect, we may reject the Mailing Items. Where we have statistically significant evidence that the error declared on the Manifest represents an error across all relevant segments, then we may revert the Mailing Items to the correct Postage by amending the Posting based upon the statistically significant evidence.

10.1.3 Meeting the Service specification

Non-compliance event	Remedial actions
<p>a. Advertising Mail, Partially Addressed Mail, Business Mail, Business Mail Large Letter, Magazine Subscription Mail or Mailmark Economy Mailing Items do not meet the declared specification (including the provision of samples and seeds if applicable).</p>	<p>We may:</p> <ol style="list-style-type: none"> 1. reject that Posting or relevant segment of the Posting; or 2. if we believe it is reasonably practicable for us to do so, process the Posting(s) or relevant segment of the Posting(s). In this case we will amend the Posting Docket (or in the event you are using eManifest Billing (see Appendix Q of this User Guide) we will issue an invoice using the eManifest you have uploaded subsequent to Revenue Protection processes being completed) and the Posting(s) or relevant segment of the Posting(s) will be charged at the Access Charges for the Access Service specification that the Mailing Items do meet. Where we have statistically significant evidence that the error declared on the Manifest represents an error across all relevant segments, then we may revert the Mailing Items to the correct Access Charges by amending the Posting(s) based upon the statistically significant evidence. We may also levy an Adjustment to cover the reasonable costs of amending such Posting(s); or 3. suspend or terminate your right to post using the relevant Access Service immediately on giving written notice to you; or 4. in respect of Mailing Items posted using Royal Mail Mailmark, take any one or more actions set out in Section 10.1.1(b), Section 10.1.3(b), Section 10.3.1(f), Section 10.3.1(i) or Section 10.6.1(c) of this User Guide. <p>In respect of Business Mail Large Letter, Magazine Subscription Mail and Mailmark Economy Mailing Items, we may charge you an additional amount to recover our reasonable costs in undertaking any of the actions referred to above in this Section 10.1.3(a), and we will notify you if we take any of the above actions.</p> <p>If you fail to provide Advertising Mail and/or Partially Addressed Mail samples or seeds as specified in Paragraph 3 of Part 1 of Schedule 4 of the Contract: Royal Mail Advertising Mail and Royal Mail Partially Addressed Mail, Paragraph 6.5 of Part 1 of Schedule 4: Royal Mail Advertising Mail and Royal Mail Partially Addressed Mail shall apply.</p>
<p>b. Mailing Items declared as Mailmark option fail to meet the Mailmark specification or require manual or other intervention.</p>	<p>We may:</p> <ol style="list-style-type: none"> 1. hold the Mailing Items until you give us complete and accurate documentation; and/or 2. reject the Mailmark Mailing Items; and/or 3. if we believe it is reasonably practicable for us to do so, rectify and process the non-compliant Mailmark Mailing Items provided that you shall pay the applicable Adjustment and/or Mailmark Adjustment; and/or 4. allow you to hand over the Mailmark Mailing Items but charge you the applicable Access Charges for the Access Service specification that those Mailing Items actually meet; and/or

	<p>5. if the number of non-compliant Mailmark Mailing Items exceeds 25% of the total volume of a Mailmark Mailing in a day, request an improvement plan for the affected Supply Chain. If the improvement plan fails to achieve 75% compliance within the agreed time, we will suspend the Supply Chain until such time it achieves 75% compliance.</p>							
<p>c. Mailing Items declared as Manual Mailmark option fail to meet the Manual Mailmark specification or require manual or other intervention.</p>	<p>We may:</p> <ol style="list-style-type: none"> 1. hold the Manual Mailmark Mailing Items until you give us complete and accurate documentation; and/or 2. reject the Manual Mailmark Mailing Items; and/or 3. if we believe it is reasonably practicable for us to do so, rectify and process the non-compliant Manual Mailmark Mailing Items provided that you shall pay the applicable Adjustment and/or Mailmark Adjustment; and/or 4. allow you to hand over the Manual Mailmark Mailing Items but charge you the applicable Access Charges for the Access Service specification that those Mailing Items actually meet; and/or 5. suspend or terminate your right to post Manual Mailmark Mail under the Contract immediately on giving written notice to you. <p>We may also charge you an additional amount to recover our reasonable costs in undertaking any of the actions in this Section 10.1.3(c), and we will notify you if we take any of the above actions.</p>							
<p>d. Mailing Items declared as General Large Letters exceed the maximum thickness for the Service.</p>	<p>We may:</p> <ol style="list-style-type: none"> 1. reject the Posting or relevant segment of the Posting; or 2. if we believe it is reasonably practicable for us to do so, process the Mailing Items but prior to doing so we will determine whether the operational impact is LOW, MEDIUM or HIGH and revert the Mailing Items as follows: <table border="1" data-bbox="678 997 2101 1345"> <tr> <td data-bbox="678 997 1003 1118">Low Impact</td> <td data-bbox="1003 997 2101 1118">When non-compliant General Large Letters are found in a Container, we will revert 10% of the General Large Letters in the Container to Parcels and apply the applicable Parcels postage charge for those items.</td> </tr> <tr> <td data-bbox="678 1118 1003 1270">Medium Impact</td> <td data-bbox="1003 1118 2101 1270">When non-compliant General Large Letters are found in two or more Containers at a single Mail Centre, we will revert 10% of the General Large Letters for that Posting or relevant segment of that Posting at that Mail Centre to Parcels and apply the applicable Parcels postage charge for those items.</td> </tr> <tr> <td data-bbox="678 1270 1003 1345">High Impact</td> <td data-bbox="1003 1270 2101 1345">When non-compliant General Large Letters are found in two or more Containers at 3 or more Mail Centres, we will revert 10% of the General Large Letters for the Posting(s), or</td> </tr> </table>		Low Impact	When non-compliant General Large Letters are found in a Container, we will revert 10% of the General Large Letters in the Container to Parcels and apply the applicable Parcels postage charge for those items.	Medium Impact	When non-compliant General Large Letters are found in two or more Containers at a single Mail Centre, we will revert 10% of the General Large Letters for that Posting or relevant segment of that Posting at that Mail Centre to Parcels and apply the applicable Parcels postage charge for those items.	High Impact	When non-compliant General Large Letters are found in two or more Containers at 3 or more Mail Centres, we will revert 10% of the General Large Letters for the Posting(s), or
Low Impact	When non-compliant General Large Letters are found in a Container, we will revert 10% of the General Large Letters in the Container to Parcels and apply the applicable Parcels postage charge for those items.							
Medium Impact	When non-compliant General Large Letters are found in two or more Containers at a single Mail Centre, we will revert 10% of the General Large Letters for that Posting or relevant segment of that Posting at that Mail Centre to Parcels and apply the applicable Parcels postage charge for those items.							
High Impact	When non-compliant General Large Letters are found in two or more Containers at 3 or more Mail Centres, we will revert 10% of the General Large Letters for the Posting(s), or							

		the relevant segment of the Posting to Parcels, and apply the applicable Parcels postage charge for those items.
		If we determine that the number of non-compliant General Large Letters found in the Container(s) is excessively high, the 10% cap on the reversion of General Large Letters to Parcels will no longer apply and 100% of the items at the level of impact we have identified will be reverted from General Large Letters to Parcels.
e. Poll Cards fail to meet the Mailmark specification or require manual or other intervention.	We may:	<ul style="list-style-type: none"> where possible, rectify the non-compliant Mailmark Mailing Items and accept those Mailing Items as rectified provided that you shall pay a Mailmark Adjustment on those Mailing Items relative to the non-compliance; or allow you to hand over the Mailmark Mailing Items but charge you the applicable Access Charges for the Access Service specification that those Mailing Items actually meet; or reject the Posting or relevant segment of the Posting.
10.1.4 Filling the Mailing Items		
Non-compliance event	Remedial actions	
a. Mailing Items contravenes the list of prohibited items, restricted items and valuable items contrary to Section 3.2 of this User Guide.	We may reject the Posting or relevant segment of the Posting.	
b. Mailing Items contain scam mail contrary to Section 3.2 of this User Guide.	We may reject the Posting or relevant segment of the Posting.	
10.1.5 Applying the Indicum and indicators		
Non-compliance event	Remedial actions	
a. Mailing Items do not bear an Approved Indicum of the Customer or the Royal Mail Access Indicator.	We may reject the Posting or relevant segment of the Posting.	
b. Mailing Items do not bear a Royal Mail postage stamp or other Royal Mail	We may reject the Posting or relevant segment of the Posting.	

mark, impression or device (other than the Royal Mail Access Indicator) and is handed over at an Inward Mail Centre.	
c. Zonal items do not bear a Zonal Indicator or bear an incorrect Zonal Indicator.	<p>We may:</p> <ol style="list-style-type: none"> 1. reject the Posting or relevant segment of the Posting; or 2. on prior arrangement with us, you may upload and pay for those Mailing Items at Zone C, except for those Mailing Items for destination to the London Zone in which case you may upload and pay for all such Mailing Items as Zone D; or 3. if we believe it is reasonably practicable for us to do so, process the Posting or relevant segment of the Posting provided that you shall pay for all items as Zone C unless the items are for the London Zone in which case they will be charged as Zone D.

10.1.6 Meeting processing requirements and segregating your Mailing Items by processing option

Non-compliance event	Remedial actions
a. Mailing Items within a Posting, UCID Posting or Consolidated are not segregated by Mailmark, Manual or Manual Mailmark Item.	<p>We may:</p> <ol style="list-style-type: none"> 1. reject the Posting or relevant segment of the Posting; or 2. if we believe it is reasonably practicable for us to do so, process the Mailing Items provided that you shall pay the applicable Adjustment.

10.1.7 Meeting Format requirements and Segregating your Mailing Items by Format

Non-compliance event	Remedial actions
a. Letters and Large Letters are mixed in a Container.	<p>We may:</p> <ol style="list-style-type: none"> 1. reject the Posting or relevant segment of the Posting; or 2. if we believe it is reasonably practicable for us to do so, we will correctly segregate the Mailing Items provided that you shall pay the applicable Adjustment; or 3. if we believe it is reasonably practicable for us to do so, we will process the Mailing Items and all Mailing Items will be charged at the applicable Large Letter Service.

<p>b. Handing over Mailing Items that exceed the maximum size dimensions for the relevant Format as set out in this User Guide.</p>	<p>We will reject the Posting or relevant segment of the Posting.</p> <p><i>If you wish to post Mailing Items that exceed these dimensions you should use an appropriate alternative service, such as our Standard Parcels service for non-urgent and non-time-critical delivery, or the Parcelforce Worldwide range of guaranteed parcel services.</i></p>
---	---

10.2 Choosing, filling and labelling your Containers

Sections 4 and 5 of this User Guide sets out the requirements for choosing Containers, filling your Mailing Items in Containers and applying labels to the Containers. Clause 3.5 of the General Terms and Conditions of the Contract also sets out a requirement for you to make sure that each Posting you hand over to us contains a minimum of four thousand (4,000) Mailing Items, and if UCID Postings are handed over within the Posting, that each UCID Posting contains a minimum of four thousand (4,000) Mailing Items.

This Section 10.2 sets out the remedial action we may take in the event you do not comply with the requirements set out at Sections 4 and/or 5, and Clause 3.5 of the General Terms and Conditions.

10.2.1 Choosing your Container

Non-compliance event	Remedial actions
<p>a. Mailing Items are not handed over in the correct Container required for the Service or Format declared, or fails to adhere to the relevant Container requirements, including labelling and sealing.</p>	<p>We may:</p> <ol style="list-style-type: none"> 1. reject the Posting or relevant segment of the Posting; or 2. if we believe it is reasonably practicable for us to do so, process the Mailing Items provided that you shall pay the applicable Adjustment to cover the reasonable costs of any additional handling that may be incurred in processing the Mailing Items and/or any administration costs.
<p>b. Mail for Guernsey handed over in Trays instead of bags, and you have not agreed to Schedule 5, Part 2: Tray Decanting as part of the Contract.</p>	<p>We may reject the Posting or relevant segment of the Posting.</p>

10.2.2 Presenting your Mailing Items in Containers

Non-compliance event	Remedial actions
a. Mailing Items are not handed over in the correct Container required for the Service or Format declared, or fails to adhere to the relevant Container requirements, including labelling and sealing.	We may: <ol style="list-style-type: none"> 1. reject the Posting or relevant segment of the Posting; or 2. if we believe it is reasonably practicable for us to do so, process the Mailing Items provided that you shall pay the applicable Adjustment to cover the reasonable costs of any additional handling that may be incurred in processing the Mailing Items and/or any administration costs.
b. Mailing Items are not correctly faced and/or bundled in line with the Presentation Specifications for the Service and/or Container in which the Mailing Items are presented.	We may: <ol style="list-style-type: none"> 1. reject the Posting or relevant segment of the Posting; or 2. if we believe it is reasonably practicable for us to do so, process the Mailing Items provided that you shall pay the applicable Adjustment.
c. You hand over Mailing Items in poor condition.	We may reject the Posting or relevant segment of the Posting.
d. The Containers you use to hand over Mailing Items are damaged or in a generally poor condition.	We may reject the Posting or relevant segment of the Posting.
e. You hand over Mailing Items that are stuck together.	We may: <ol style="list-style-type: none"> 1. reject the Posting or relevant segment of the Posting; or 2. if we believe it is reasonably practicable for us to do so, separate and process the Mailing Items provided that you shall pay the applicable Adjustment.
f. Containers are not presented in Yorks as required for Acceptance By Vehicle.	We shall refuse to accept the vehicle.
g. The weight of any Royal Mail approved Container exceeds the maximum weight specified for it.	We may reject the relevant Container which will be held and either: <ol style="list-style-type: none"> 1. you shall collect the overweight Container; or

	2. if we believe it is reasonably practicable to do so, we will levy an Adjustment for breaking down the Posting or relevant segment of the Posting into compliant Container fills, so that we meet our Health & Safety standards.
--	--

10.2.3 UCID Postings

Non-compliance event	Remedial actions
a. Failure to use a UCID in accordance with the terms of the Contract and this User Guide, including failing to clearly identify and/or segregate UCID Postings as required.	<p>Where you use a valid UCID, we will restrict the remedial actions we may take under Clause 3 of the Contract and this Section 10 of this User Guide against any non-compliant Mailing Items we find through our revenue protection processes, to those Mailing Items bearing the same UCID in the Posting.</p> <p>If you fail to use a UCID in accordance with the terms of your Contract and this User Guide, you will lose the right for your UCID to be recognised for the purposes of Revenue Protection. We will not be able to treat Mailing Items which are contained in such Containers as separate Postings for Revenue Protection purposes, where you have failed to clearly identify and/or segregate those Containers as UCID Postings.</p> <p>In which case, we may reject the relevant Mailing Items and we will have to assume that any errors found apply across all such Mailing Items which have not been clearly identified as UCID Postings or segregated when requested (as applicable), and apply the provisions of Clause 3 of the Contract and this Section 10 to all such Mailing Items.</p>
b. A UCID Posting or Daily Posting comprises fewer than four thousand Mailing Items.	We may reject the Posting or segment of the Posting.

10.2.4 Under filled containers

Non-compliance event	Remedial actions
a. You do not fill your Containers to the minimum fill requirements as specified in Section 4.5 of this User Guide, and the Container fill per Selection is not maximised.	<p>You must where possible maximise the Container fill for each Selection within the Posting up to the applicable Containers' maximum allowable weight limit, subject to meeting the requirement for accurate Container contents. If we find that the number of underfilled Containers of a Posting or relevant segment of a Posting is excessive, we may reject the Containers or apply a levy an Adjustment if we process the Containers.</p> <p>Where you present a UCID Posting then one Under Volume Container per Standard Selection Code (SSC) per UCID per Service used per day will be charged at the Access Charges relevant for that Service. This is subject to all other terms and conditions being met.</p> <p>Any additional Under Volume Container will be surcharged. In calculating the surcharge for an Under Volume Container, we deduct your Actual Container Fill from the Wholesale Average Container Fill, and multiply the resulting number by the Under Volume Container Charge, giving the surcharge due for that individual Under Volume Container in each case, as set out below:</p>

	<p>(Wholesale Average Container Fill – Actual Container Fill) x Under Volume Container Charge.</p> <p>Your Actual Container Fill is the specific number of Mailing Items in an Under Volume Container that you give us on a per container basis.</p> <p>The Wholesale Average Container Fill is the total number of Mailing Items received by Wholesale in the previous Financial Year divided by the number of containers received in that period.</p> <p>Both the Wholesale Average Container Fill and the Under Volume Container Charge are published on our Website. For clarity, Under Volume Container Charges are applied in addition to the Postage charges for the Mailing Items.</p>
--	---

10.2.5 Labelling your Containers

Non-compliance event	Remedial actions
<p>a. Containers are presented at the Inward Mail Centre without labels or with missing/incorrect information on the labels or have the wrong colour labels relevant to the Service as specified in Section 5 of this User Guide, and as a result we are unable to verify the Container has been correctly declared on the Posting Docket.</p>	<p>We may reject the Posting or relevant segment of the Posting.</p>

10.3 Producing your documentation

Sections 6 and 8 and Appendix M of this User Guide sets out the requirements for producing documentation associated with your Postings, including your Posting Docket, Manifest and eManifest.

This Section 10.3 sets out the remedial action we may take in the event you do not comply with the requirements set out at Sections 6 and 8 and Appendix M.

10.3.1 Providing your documentation

Non-compliance event	Remedial actions
a. No Posting Docket(s) or Manifest(s) received as specified at Section 6.1 and Section 6.2(a).	We may refuse handover of and reject the Posting.
b. Inaccurate 06:30 Posting Docket and Manifests as specified at Section 6.1 and Section 6.2(a).	<p>On a Handover Day, if you become aware of a variance between the volume of Mailing Items for handover and your Posting Docket and Manifests due to events outside your control you must inform DSACC immediately via DocketHUB of any misrouted Containers and of any Exceptions (including additional or fewer Containers) by no later than the following times that Handover Day:</p> <ol style="list-style-type: none">06:30am for Inward Mail Centres with a handover time up to and including 09.30am08.30am for Inward Mail Centres with a handover time of up to and including 11.00am;10:00am for all other Inward Mail Centres. <p>All agreed Exceptions shall be recorded by you within DocketHUB as per the timescales above.</p> <p>Where the actual variance is in excess of the number of Containers declared and we are able to agree to the handover of the Exceptions on that Handover Day, any such Containers will be excluded from the Service Standard measure and will be processed as if they had been received on the following Working Day. We may require all additional Containers reported to DSACC via Exception reports to be handed over separately at the handover point of the relevant Inward Mail Centre.</p>
c. No Vehicle Declaration or inaccurate Vehicle Declaration provided as	We may:

<p>specified at Section 6.2(c) of this User Guide.</p>	<ol style="list-style-type: none"> agree to accept the Mailing Items if it is operationally practical for us to do so at each Inward Mail Centre. In such circumstances the accurate number of Containers must have been provided on both the Vehicle Manifest and the Summary Vehicle Manifest. In accepting the Mailing Items we may reasonably raise an administration charge for managing any additional administration work required to accept and confirm the vehicles at handover; or if it is not operationally practical for us to do so, we may refuse the Mailing Items until an accurate Vehicle Declaration is provided. 				
<p>d. No Vehicle Manifest provided as specified at Section 6.2(c) of this User Guide, or Appendix Q of this User Guide (as applicable).</p>	<p>We may:</p> <ol style="list-style-type: none"> agree to accept the Mailing Items if it is operationally practical for us to do so at each Inward Mail Centre. In such circumstances the accurate number of Containers must have been provided on the Summary Vehicle Manifest. In accepting the Mailing Items we may reasonably raise an administration charge for managing any additional administration work required to accept and confirm the vehicles at handover; or if it is not operationally practical for us to do so, we may refuse access to any vehicle that arrives at an Inward Mail Centre without having notified us in advance of its consignment by submitting a Vehicle Manifest. 				
<p>e. Hard copy Manifest(s) (including Summary Vehicle Manifest, if applicable) not received at handover at Inward Mail Centres.</p>	<p>We may allow hand over of a Posting in respect of which a hard copy Manifest(s) or Summary Manifest is not provided to us by a driver, subject to the receipt of the Posting Docket and electronic Manifest by 06:30am on the Handover Day. However, the Posting will not be processed until such time as the hard copy Manifest(s) relating to that Posting(s) is received at the Inward Mail Centre and the Posting(s) shall be deemed to have been received on the following Working Day.</p> <p>If the Manifest(s) is not received within 24 hours, we may reject the Posting(s). In this case, the Posting Docket(s) will be adjusted and the Mailing Items must be included on a subsequent and relevant Posting Docket(s).</p> <p>We may refuse handover of any subsequent Postings at the Inward Mail Centre(s) affected until the relevant Manifest(s) has been received.</p>				
<p>f. For Mailmark Mailing Items:</p> <ol style="list-style-type: none"> you have not uploaded your posting data to the eManifest Handling Service (eMHS) to create the eManifest: <ol style="list-style-type: none"> by 05:00 on the Handover Day, for mail you produce via a machine consolidation process; and 	<p>We may:</p> <ol style="list-style-type: none"> hold the Mailmark Mailing Items until you give us complete and accurate documentation; reject the Mailmark Mailing Items; or apply an Adjustment, using the following criteria, to cover our administration costs relating to any remedial actions taken: 				
	<p>Number of unmanifested items per SCID posting per day</p>	<p>Apply Mailmark Business Mail Postage price</p>	<p>Apply fixed admin fee</p>	<p>Apply per item unmanifested adjustment charge</p>	<p>Apply per item non-compliance charges (e.g. DPS/Postcode Inaccuracy /Missorts)</p>

<p>ii. by 23:30 on the day before the Handover Day, for all other pre-sorted Mailing Items; or</p> <p>2. there are errors known by you prior to handover to us relating to the upload of your posting data to the eMHS to create the eManifest.</p>	Less than 500	No	No	No	Yes
	Between 500 – 6000	Yes	Yes	No	Yes
	More than 6000	Yes	No	Yes	Yes
<p>g. For Manual Mailmark Mailing Items:</p> <p>1. you have not uploaded your posting data to the eManifest Handling Service (eMHS) to create the eManifest:</p> <p>i. by 05:00 on the Handover Day, for mail you produce via a machine consolidation process; and</p> <p>ii. by 23:30 on the day before the Handover Day, for all other pre-sorted Mailing Items; or</p> <p>2. there are errors known by you prior to handover to us relating to the upload of your posting data to the eMHS to create the eManifest.</p>	<p>We may:</p> <p>1. hold the Manual Mailmark Mailing Items until you give us complete and accurate documentation;</p> <p>2. reject the Manual Mailmark Mailing Items; or</p> <p>3. apply an Adjustment, using the following criteria, to cover our administration costs relating to any remedial actions taken:</p>				
	Number of unmanifested items per SCID posting per day	Apply Access 70 Manual Mailmark GLL Postage price for the Manual Mailmark Mailing Items	Apply fixed admin fee	Apply per item unmanifested adjustment charge	Apply per item non-compliance charges (e.g. DPS/Postcode Inaccuracy /Missorts)
	Less than 500	No	No	No	Yes
	Between 500 – 6000	Yes	Yes	No	Yes
	More than 6000	Yes	No	Yes	Yes
<p>h. The number, weight or Format of Manual Items declared on the Manifest(s) does not align with the number, weight or Format of Mailing Items handed over.</p>	<p>We will revert your Mailing Items to the correct Postage by amending the Posting Docket(s) and Manifest(s). Where we have statistically significant evidence that the number of Mailing Items declared on the Manifest(s) represents an error across a Posting or relevant segment of a Posting, then we may amend the Posting Docket based upon the statistically significant evidence.</p>				

	Exception to this remedy for weight variances on Mixed Weight Postings: Due to the Mixed Weight system constraints, if an Under Volume Container is sampled on a Mixed Weight Posting, and the actual weight of the Mailing Items handed over differs from the declared value, we will invoice the declared value only.
i. The number, weight or Format of Mailmark Mailing Items, declared on the Manifest(s) does not align with the number, weight or Format of Mailmark Mailing Items handed over.	For Mailmark Mailing Items where discrepancies, are identified through manual and / or in-process reporting, we will correct the volume, weight or Format of items and apply the relevant Access Charges to those corrected items. Note: Where this happens, the Posting Docket adjustments may appear on a subsequent invoice.
j. No Agency overlay report provided by 18:00 on the Handover Day.	We will invoice you as per the approved Client Report for that day and we may levy a charge to you for any adjustments that you require to be made to your invoice once we have issued it to you.
k. Inaccurate or error within the Agency overlay report provided for the Daily Posting.	We shall at your request and cost, issue amended invoices and/or credit notes to your Agency Customers, providing we receive such a request within 2 Working Days, otherwise the request may be refused.

10.4 Procedures before you handover mail

Section 8 of this User Guide sets out the procedures you must follow prior to handing mail over to us, such as booking Access Slots and submitting forecasts.

This Section 10.4 sets out the remedial action we may take in the event you do not comply with the requirements set out at Section 8.

10.4.1 Booking Access Slots

Non-compliance event	Remedial actions
a. No Access Slot has been booked for an Inward Mail Centre.	If you arrive at an Inward Mail Centre without booking an Access Slot then we may reject the Posting. If you still wish to hand over the Posting, you must contact DSACC to agree arrangements for the handover of the Posting.
b. No notification provided for multiple vehicles in a pre-booked Access Slot.	If you arrive at an Inward Mail Centre with multiple vehicles without having notified us, then we may refuse handover of and reject the Posting. If you still wish to hand over the Posting, you must contact DSACC to agree arrangements for the handover of the Posting.
c. You arrive at the Inward Mail Centre time outside of Access Window.	We may refuse the handover of and reject the Posting.
d. You arrive at the Inward Mail Centre outside of the Access Slots.	If you are unable to arrive during the agreed Access Slot you must inform DSACC at the earliest opportunity to request an alternative arrival time and agree on arrangements for the handover of the Posting. If you arrive before the Access Slot (but within the Access Window) we may allow handover of the Posting if operationally feasible. If we are unable to accept handover the driver will be asked to wait or leave the premises until your allocated Access Slot or an earlier Access Slot becomes available. If you arrive after the Access Slot (but within the Access Window) we will allow handover of the Posting if operationally feasible for us, subject to you gaining prior approval from DSACC. If the Posting can only be accepted after the Access Slot (but outside the Access Window), your nominated contact may be notified by DSACC that the Posting will not form part of the Service Standard measurement for the purposes of Paragraph 2 of Part 1 of Schedule 2 of the Contract: Service Standard and General Service Obligations, and will be processed as if it had been received on the following Working Day.

	If you arrive during the agreed Access Slot but you are unable to hand over the Posting due to a reason attributable to us, we will allow handover of the Posting in the next available Access Slot. The Posting will be treated (including for the purposes of the Service Standard) as having been handed over during the earlier Access Slot.
10.4.2 Forecasting	
Non-compliance event	Remedial actions
a. No receipt of 1-day forecast.	<p>We may refuse handover of and reject the Posting.</p> <p>If you fail to provide the 1-day forecast by 10:00am on the Working Day prior to Handover Day and you still wish to hand over the Posting, you must contact DSACC to agree arrangements for the handover of the Posting.</p> <p>If we have not received a forecast of the Posting due to a failure on our part we will accept handover of the Posting affected by the failure.</p>
b. Inaccurate 7-day or 1-day forecast.	<p>If the actual volume of Mailing Items broken down by Format and processing option (i.e. Mailmark Letter, Mailmark Large Letter, Manual Letter, Manual Large Letter), which you hand over at an individual Inward Mail Centre exceeds the number notified under Section 8.3(a) by more than the Tolerance (“under forecasting”), we may:</p> <ol style="list-style-type: none"> 1. refuse the handover of; or 2. accept the handover of any Mailing Items that are in excess of the Tolerance. <p>We shall use reasonable efforts, subject to Clause 3 of the Contract, to allow handover or to accept the Mailing Items.</p> <p>Where we accept Mailing Items in line with the above, the number of Mailing Items in excess of the Tolerance shall not form part of the Service Standard measurement for the purposes of Paragraph 2 of Part 1 of Schedule 2: Service Standard and General Service Obligations, and will be processed as if they had been received on the following Working Day.</p> <p>If the actual volume of Mailing Items, broken down by Format and processing option, that you handover at an Inward Mail Centre is less than the number notified under Section 8.3(a) by more than the Tolerance (“over forecasting”), we may levy an “Over-forecasting” charge.</p> <p>For the purpose of this section Tolerance is the greater of:</p> <ol style="list-style-type: none"> 1. 1000 Letters or Large Letters (as appropriate); or 2. 15% of the number notified in your 1-day forecast or as notified under the Key National Posting (KNP) process specified in Appendix B of this User Guide (as applicable).
c. Non-arrival of Posting.	Where you have provided us with a Forecast and you do not inform us on the Working Day before the Handover Day that you wish to cancel a Posting, we may levy a charge. This charge is called “Vehicle No Show”. The Posting will be considered void and will be logged by DSACC.

	If in the unlikely circumstance that you have sent us a Posting Docket and Manifests but you are unable to handover the Posting at any Inward Mail Centre, you must contact DSACC as soon as possible.
--	--

10.5 Handing over your Postings
 Section 9 of this User Guide sets out the procedures you must follow prior to handing mail over to us, such as following health and safety procedures, and procedures whilst at our sites.

This Section 10.5 sets out the remedial action we may take in the event you do not comply with the requirements set out at Section 9.

10.5.1 Security and health and safety compliance

Non-compliance event	Remedial actions
a. Failure to comply with our site security and health and safety procedures.	We will refuse your driver access or ask him or her to leave.

10.5.2 Unloading and handover

Non-compliance event	Remedial actions
a. Discrete Customer Postings are not identifiable due to missing or inaccurate York Card(s).	<p>If one York at an Inward Mail Centre has a York card missing or an inaccurate York card, we may refuse handover of the York and require you to collect the York, or we may accept the York subject to the Discrete Customer Postings within the York agreeing with the Manifest.</p> <p>If more than one York at an Inward Mail Centre has a York card missing or an inaccurate York card, we will refuse handover of the Yorks. In such cases, you must collect the Yorks whose contents have not been clearly identified and we may levy a charge to cover the reasonable costs of handling.</p>
b. Discrete Customer Postings are not reasonably segregated within a York by cardboard or other effective means.	If you are not using Segregation by Format (see Section 3.6(b) of this User Guide) and you fail to reasonably segregate Discrete Customer Postings within a York by cardboard or other effective means, we may reject the York(s), require you to collect the York(s) and we may levy a charge to cover the reasonable costs of handling.
c. Discrete Customer Postings are not correctly segregated on handover (e.g. Containers from a Zonal option	Where you are handing over Discrete Customer Posting(s), if you do not maintain segregation of the Discrete Customer Posting(s) then we may reject them.

are mixed with Containers from a National Price Plan option; or Containers from a Mixed Weight Posting are mixed with Containers from a non-Mixed Weight Posting.)

This remedial action is not applicable if you are using Segregation by Format (see Section 3.6(b) of this User Guide).

10.6 Miscellaneous	
10.6.1 Missorts	
Non-compliance event	Remedial actions
a. Containers of Mailing Items for delivery to certain Postcodes are handed over to the wrong Inward Mail Centre (misrouted Container).	We may reject the relevant Containers which will be held and either: <ol style="list-style-type: none"> 1. you shall collect the wrongly handed over Containers and we may levy a charge to cover the reasonable costs of handling the Containers; or 2. if we believe it is reasonably practicable to do so, we will process the Containers, but we will amend the Posting Docket to reflect that the Mailing Items will be charged at the Missort Processed item rate displayed on our Website.
b. Missorted Manual Items are found during the processing of the Posting.	We may reject those Mailing Items and either: <ol style="list-style-type: none"> 1. you must collect the missorted Mailing Items from the relevant Inward Mail Centre and we may levy a charge, the "Missort Return Charge". This Missort Return Charge includes a per item price and a collection charge per Inward Mail Centre collection. Where such charges are levied, we shall refund you for those missorted Mailing Items at the relevant agreed Access refund rate. The charges and the Access refund rate will be set each time we adjust our tariff. The Missort Return Charge and the Access refund rate are displayed on the Website; or 2. if we believe that it is reasonably practicable we will process the Mailing Items. In this case we may revert the Mailing Items to the correct Postage by amending the Posting Docket to reflect that the relevant Mailing Items will be charged at the "Missort Processed" rate displayed on our Website. Where such a charge is levied, we shall refund you for those missorted Mailing Items at the relevant agreed Access refund rate.
c. Missorted Mailmark Mailing Items, are found during the processing of the Posting.	Mailmark Mailing Items identified as missorts through in-process reporting will not be returned to you. We will process and deliver the Mailing Items and apply the applicable Mailmark Adjustments as published on the Website.
10.6.2 Ineligible services	
Non-compliance event	Remedial actions

<p>a. Mailing Items are handed over that are not eligible for Access (e.g. International and BFPO addresses).</p>	<p>If we find ineligible Mailing Items at the point of handover or during the processing of the Posting(s) (after handover or acceptance), we may refuse handover or reject the Mailing Items, as applicable. You must collect the ineligible Mailing Items from the relevant Inward Mail Centre and we may levy a charge to cover the reasonable costs of handling. We will refund the Access charges raised against the equivalent volume of ineligible Mailing Items identified at the Access refund rate which is displayed on the Website.</p> <p>We may levy ineligible item charges for each ineligible Mailing Item found, extracted and returned, at a per item price plus a collection charge per Inward Mail Centre collection. Ineligible item charges are displayed on the Website.</p>
<p>b. You have declared items as OCR or Access 1400, both discontinued services.</p>	<p>You will be charged at Access 70 Postage charges.</p>
<p>10.6.3 Zonal option</p>	
<p>Non-compliance event</p>	<p>Remedial actions</p>
<p>a. You do not meet the additional Zonal presentation requirements set out in Appendix C of this User Guide.</p>	<p>We may reject the Posting or relevant segment of the Posting.</p>

Appendix A: Addressing Mailing Items

To meet the required address standards you must ensure that each address on a Mailing Item includes at least:

- one premises element;
- one thoroughfare element;
- one locality element; and
- the Postcode as a minimum.

Other elements may be included. If there is no thoroughfare element contained in PAF® this need not be included.

Each element is described below:

PAF Format		Element
Organisation	Royal Mail	Premise
Sub Building		
Building Name	Wheatstone House	
Building Number		
Dependent Thoroughfare		Thoroughfare
Thoroughfare	Wheatstone Road	
Double Dependent Locality		Locality
Dependant Locality	Dorcan	
Post Town	SWINDON	
County		Not required
Postcode	SN3 5XX	Postcode

1 Premises elements

1.1 All Mailing Items must include at least one of these four elements, so that a single delivery point is defined. You do not have to include all the premises elements (unless the premises elements used do not sufficiently describe an address), even if they are included in PAF®, but building numbers must be applied on the same line as the dependent thoroughfare or thoroughfare information.

1.2 You should make reasonable efforts to check the addressee name and Delivery Address of a relevant Mailing Item against the latest version of the Mailing Preference Service's Suppression File before you hand over the Mailing Item to us. You can get the Mailing Preference Service's Suppression File from the Mailing Preference Service, DMA House, 70 Margaret Street, London W1W 8SS.

2 Thoroughfare elements

2.1 PAF® will give one of three possible combinations:

- No thoroughfare: no need to include anything in this part of the address.
- A thoroughfare but not a dependent thoroughfare: include the thoroughfare.

- c. Both a dependent thoroughfare and a thoroughfare: include the dependent thoroughfare. If space allows you can also include the thoroughfare, though it is not compulsory.

3 Locality elements

- 3.1 You must include at least one locality element. The address does not have to include all locality elements, even if they are included in PAF®.
- 3.2 The initial letter(s) of the post town must always be in capital letters, for example Milton Keynes. Alternatively the whole of the post town may be in capital letters, for example: BIRMINGHAM on a line on its own, as can the whole of the Delivery Address.

4 Postcode

- 4.1 The address must contain the full and accurate Postcode. The Postcode must be able to generate an address from PAF® which can be matched to the minimum requirements above (at least one premise element, one thoroughfare element and one locality element). The Postcode must always appear in capital letters and, unless with the exception of examples set out at Section 5(b) below, on its own as the last line of the address.
- 4.2 Do not include any punctuation or underline the Postcode. Please put one or two character spaces between the two parts of the Postcode. The first part (i.e. SN3) is the outward code; the second (i.e. 5XX) is the inward code.

5 Address Structure

- 5.1 Each address element must be on a separate line with the Postcode included as the last line of the address.

Royal Mail
Wheatstone House
Wheatstone Road
Dorcan
SWINDON
SN3 5XX

- 5.2 Where the address complies with PAF® and there is no other text or information on the face of the Mailing Item that could be construed as an address, then the following exceptions apply:

- a. The Postcode may be preceded by a county on the last line of the address, provided that the space between the county and the Postcode is one or two characters.

Royal Mail
Wheatstone House
Wheatstone Road
Dorcan
SWINDON
Wiltshire SN3 5XX

- b. The post town may be followed by a county on the penultimate line of the address, provided that the space between the post town and county is one or two characters and that the Postcode is on the last line of the address.

Royal Mail
Wheatstone House
Wheatstone Road
Dorcan
SWINDON Wiltshire
SN3 5XX

- c. The post town and Postcode may be jointly on the last line of the address, provided that the post town precedes the Postcode and the space between the two elements is one or two characters.

Royal Mail
Wheatstone House
Wheatstone Road
Dorcan
SWINDON SN3 5XX

The County, although not required, may be included as the penultimate line of the address, provided that the space between the post town and county is one or two characters and that the Postcode is on the last line of the address.

6 Zonal Addressing

- 6.1 See Appendix C for details of the addressing standard requirements for Zonal Postings.

7 General advice for print quality and finishing

- 7.1 Digital printing processes apply a pigment layer that adheres to the surface of the paper. The layer does not soak into the paper and is softer than standard inks.
- 7.2 Consequently, when used for mail, the pigment may rub off, transfer to adjacent surfaces (inserts and the envelope), crack, and become marked both during the manual and automated handling process.
- 7.3 The application of an ultra-violet (UV) cured varnish has been found to reduce wear to digitally printed Mailing Items. This provides a protective coating over the pigment. It should only be applied to the non-addressed side of the Letter as the characteristics of the varnish may make the Mailing Items unmachinable if applied to both sides (they may have 'window-like characteristics' that reduce mechanical handling capability, increase static cling, and compromise code mark printing).
- 7.4 The pressure exerted on the Letter during automated processing may cause colour offset on digitally printed items. Therefore, it is recommended that there should be no off-set of print or colour transfer when the items are exposed to a pressure of 3.43kPa (35g per cm²). This equates to a weight of 8.5kg spread over the surface of a DL envelope, and 13.5kg for C5 envelopes.

8 Where to go for more information

- 8.1 For more information or to order Managing Address Data products:
 - a. Call Royal Mail on 0845 606 6854
 - b. Visit the Royal Mail Website at www.royalmail.com/amu
 - c. Order products via the Royal Mail Website shop at www.royalmail.com/shop
 - d. Order products online from: address.management@royalmail.com

Appendix B: Key National Posting (KNP)

1 Introduction

- 1.1 This appendix defines the process for managing KNPs. It describes the communication channels, the flow of information and the actions required by each link within the process.
- 1.2 The KNP process applies to all Access Services offered and is in addition to and does not replace any existing processes for handling Postings as described in the User Guide. The effectiveness of a KNP is largely dependent on the timeliness of the exchange of key information between you and us.
- 1.3 The KNP process is designed to ensure advance notice is provided for all Postings that require additional planning and management because they are exceptional to the norm of particular importance (e.g. public health messaging) and/ or because of their volume, size, shape or geographical bias.
- 1.4 The KNP process is used to raise the awareness of particular Postings to ensure these Postings are planned, communicated and executed to meet the product specification and quality of service in an efficient and cost-effective manner to the benefit of all concerned.
- 1.5 Failure to provide the necessary information may result in Mailing Items not being delivered within the expected timescales, and we may manage the handling and delivery of Mailing Items to ensure excessive costs are not incurred.

2 What is a KNP?

- 2.1 A KNP is any Posting, which may cause operational challenges or difficulties and may not be successful or meet quality of service unless it is planned discretely from 'business as usual' postings and the plans implemented.
- 2.2 It should be noted that individual Postings may not in themselves cause operational difficulties, but may contribute to such concerns when combined with other such postings, or planned at specific seasonal times of the year. Therefore, if any Posting fits any of the criteria described at Annex A of this appendix, the KNP process must be followed. We maintain the right to manage any posting as a KNP if it is deemed to have an operational impact, or be exceptional due to its size, weight, or geographical delivery bias.
- 2.3 All poll card and council tax mailings are All considered to be KNPs. See Appendix P for further details on poll cards.

3 KNP process

- 3.1 A KNP must be communicated and raised at the earliest possible opportunity via the appropriate Royal Mail Wholesale channel. The timeline specified at Annex B of this appendix will then be implemented by both parties, and the exchange of information progressed to deliver an effective and efficient posting.

4 Entry Level

- 3.1 Volume is not the only determining factor; the issue for us (and other operators) is one of workload and capacity. A common sense approach is applied to Postings that may reasonably be considered to be exceptional because of their volume, size, shape or geographical bias and/or show a significant spike in your normal posting pattern. Annex B provides the timeline.

5 Documentation

- 5.1 For all KNP Postings, you must submit a fall to earth (FTE) of the mailing profile on at least 7 Working Days' notice prior to the Posting being handed over to us. The format of the fall to earth is shown in

Annex C of this appendix. The notification of KNP, including sharing of the FTE, is done through DocketHub.

5.2 You must also include the KNP posting in your 7-Working Day forecast (see Section 8.2) and 1-day forecast (see Section 8.3).

5.3 Any changes to the posting data including the FTE and handover date after submission must be notified immediately to us.

6 Access Slots

6.1 If additional Access Slots are required to handover the KNP, then you or your carrier must book the additional Access Slots at least 2 Working Days prior to the KNP being handed over to us at the specific Inward Mail Centre. See Section 8.1 on how to book Access Slots.

7 Annex A - Access KNP Criteria

7.1 Mailing Items which you plan to handover, that meet the criteria below, must be notified to us using the DocketHub KNP functionality, to us a minimum of 28 days before the first date of handover to enable detailed operational planning to take place. (28 days has been specified as it is reasonable to expect that the details of the Posting to be known at that point).

7.2 If you fail to notify us of a KNP Posting in accordance with the timeline at Annex B we may handle the Posting over a number of days; the number of days to be determined by us.

7.3 In addition to the total volume of Mailing Items being posted, other criteria may also determine if a Posting is a KNP:

- a. Mailing Items of an unusual size/shape or weight;
- b. Mailing Items that do not fit through the average sized letter box as defined by the European Standards Commission (this can be obtained on request);
- c. A Posting with a geographical bias. This may include National Postings that may have a geographical bias as a result of the production order and handover of the Posting. Poll card and council tax mailings are examples of these.

Volume	Impact grid to be used as a guide for all Access Services					
	>1m	Red		Amber	Red	
750k-1m	Red		Green	Red		Green
500K-750K	Red		Green	Red		Green
250K=500K	Amber		Green	Amber		Green
125K-250K	Amber		Green	Amber		Green
0-125K	Amber		Green	Amber		Green
Format	Letter			Large Letter		
Impact	Geographical bias	Unusual format	National	Geographical bias	Unusual format	National
Access Sortation	70	70	70	70	70	70
Access Service	Machinable or manual	Manual	Machinable or manual	Machinable or manual	Manual	Machinable or manual

Key:

Red = KNP

Amber = Possible operational impact, therefore, KNP status considered. Please discuss with your Account Handler

Green = Not considered a KNP

8 Annex B - KNP timeline

Activity	Time before posting date	Date expected	Clarification of information required	Date complete
Advise commencement date of Posting	- 28 days		Date to be confirmed - will be first handover at RM Inward Mail Centres	
Format and sortation of Mailing Items	- 28 days		Item format, weight & sortation level to be confirmed	
Volume of Mailing Items other criteria (see App. A above)	- 28 days		Total volume and estimated volumes other criteria by Handover Day	
Item weight and description	- 21 days		Example mailpiece (if available) and exact weight of item to be provided.	
Return address	- 21 days		UK returns to sender address to be supplied	
Response item	- 21 days		Is a response item contained within mail item	
Order additional supply of Consumables	- 14 days		Carrier to order	
Order additional supply of containers	- 14 days		Carrier to order	
Presentation and containerisation of Mailing Items	- 14 days		Containers & presentation of Mailing Items to be confirmed	
Book additional Access Slots	- 14 days		Carrier to book any additional Access Slots via DocketHUB	
Ensure drivers and vehicles are on DocketHUB	- 14 days		Carrier to upload to DocketHUB	
Fall to earth for each day of handover to be uploaded to DocketHUB	-7 Working Days		Information required see Annex C	
Formal confirmation of posting dates	-7 Working Days		Confirm dates, format & item weights to us	
Include KNP in 7-Working Day forecast	-7 Working Days		Upload into DocketHUB	
Include KNP in Forecast	- 24 hours		Upload into DocketHUB	
Upload KNP data to relevant posting docket	By 06:30 on Handover Day		Upload into DocketHUB.	
Begin KNP Posting and review	0			

9 Annex C - FTE format

Date of handover	Format	No of items	No of Containers	Sortation level	SSC	Postcodes	Delivery Office	Inward Mail Centre
dd/mm/yy	XX	XX	XXX	XX	12345	XX1A	XXXXX	XXXXX

Appendix C: Zonal Option

1 Introduction

1.1 If you have opted for a Zonal Price Plan with your Contract you are required to meet certain additional presentation requirements. The following sections provide the detail of those requirements, the additional software that is available to aid those requirements and the detailed pricing formula values.

2 What is a Zone?

2.1 We have analysed the c.11000 Postcode Sectors in the United Kingdom and have allocated each of these to a Zone according to the criteria in the table below:

Zone	Definition Where DPD = Delivery Point density and BD = Business Density
A (Urban)	(BD > 10% and DPD >500) or DPD >1000
B (Suburban)	DPD <1000 >100
C (Rural)	DPD <100
D (London)	M25 Where the relevant 3 digit Standard Selection Code3 (SSC) is defined as "having more than 50% of their postal delivery volumes going to an area within the M25 boundary"

A full list of Postcode selections and Zones can be found within the Access Selection Files at www.royalmailwholesale.com

3 What is a Zonal Posting?

3.1 Zonal Postings are those where the fall-to-earth of the Mailing Items is not expected to meet the posting profile requirements of the National Price Plan One (SSC's), Averaged Price Plan Two (Zones) or Regional Price Plan (Zones). In order to price Zonal Postings we have developed Zonal Charges for each of the Services available.

3.2 Zonal Postings are priced on any given day not only by the Mailing Item weight (dependant on the band) format and Service, but also by the number of Mailing Items at each Zone, pertaining to the former criteria.

3.3 You are required to analyse each Container at this level of detail and present it to us via DocketHUB (see Figure 27). We will summarise this data for pricing purposes as presented on the Posting Docket and invoice.

4 Zonal Indicator

4.1 All Mailing Items for a Zonal Posting must carry the Zonal Indicator relevant to the Postcode sector of the corresponding address.

4.2 There are two options relating to the positioning of the Zonal Indicator on your Mailing Items (see Figure 26):

a. Within the top right-hand area of the address window immediately following the Standard Selection Code (Zone A, B, C or D), for example 53200 A; or

b. It may be preceded by the word "Zone" and be in a minimum font size of 10 point (e.g. Zone A).

4.3 Both options need to be positioned outside of any Clear Zones.

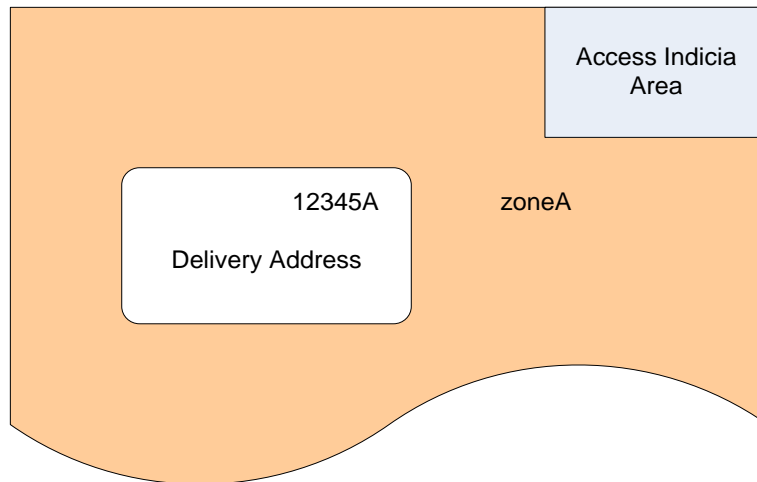

Figure 26: Positioning options for Zonal indicator

4.4 The simplest way to ensure an address is correct is to check that the minimum address elements in the appropriate PAF® records are present. To facilitate this we have developed the Access Selection Files, available to download via www.royalmailwholesale.com, which incorporate the Zonal Indicator and which will be updated monthly for new Postcode sectors. All other functionality remains as per the existing Access Selection Files. The Access Selection Files are maintained by us and linked to our Delivery and Postcode databases in order to ensure the most up to date Postcode sector analysis is available for customers to price Zonal Postings. If you have signed up to receive notifications via the Website, we will notify registered users when updates are available. It is mandatory to use the most up to date Version of the Access Selection Files. It is highly recommended, unless specifically requested as a mandatory update, that the most up to date Access Selection Files Release be used, to ensure mailing lists are priced correctly. We conduct an annual review of Postcode sectors to Zones which will be affected by publication of a new release of the Access Selection Files. Use of this specific release of these Access Selection Files is mandatory for all Zonal Postings.

5 Container labels

5.1 All Mailing Items presented under the Zonal option must have the word 'zonal' clearly visible and legible on the Container label. For more details see Section 5.

6 DocketHUB requirements

6.1 In addition to the standard data requirements for the DocketHUB interface, you will be required to provide the volume of Mailing Items at each Zone per Container. The DocketHUB technical specification can be found at www.royalmailwholesale.com and includes the specific additional coding requirements for the Zonal option. This upload will generate a Zonal Manifest (see Figure 27).

Site Manifest / Delivery Note

2. Access Site:

4. Handover Date to Royal Mail:

3. Address:

5. Account Number:

1. Account Name:

6. Docket Number:

7. Licence Number:

Job Reference:

Container Id	Manifest Id	Supply Chain Id	UCID	SSC	Post Code Area	Product Details	Zone	Items	Avg Weight (g)	Total Weight (Kg)	Declared Container Weight (Kg)	Declared Container Items
425G61000000			8RC00	344	B	70_ Letters	A	731	10	7.310	8.000	800
						Rsp Intl Tray	B	69	10	0.690		
Manifest totals for 1 Containers											8.000	800

Please Note: This Delivery note does not constitute acceptance that the above details are correct, as these details will be subject to Royal Mail revenue protection and mails verification checks. For the avoidance of doubt, this document only acknowledges the handover of mail items on the time and date specified.

Royal Mail (Please print name)

Royal Mail Signature

For Royal Mail Use Only

Handover Date to Royal Mail

Arrival Time at Royal Mail

Figure 27: Zonal Manifest

7 Pricing

- 7.1 The detailed Manifest data per Container will be summarised for pricing and invoicing purposes at the level of Access Service, Format, processing option, average item weight, and number of items per Zone.
- 7.2 The pricing methodology and the current Zonal Charges are on our Website and within Schedule 3: Price Plans of the Contract.
- 7.3 Where the address data on a Mailing Item does not have the Postcode selection in sufficient detail to identify a Zone, you must declare such Mailing Items as Zone Z, except for Mailing Items whose delivery destinations are in the London Zone, which must be declared as Zone D. Zone Z Mailing Items will be charged at Zone C prices.
- 7.4 In order for you to estimate the cost of a Zonal Posting, we have developed a pricing calculator that will enable mailing lists to be "priced" in advance of actual mail production. The calculator is available on the Website.

Appendix D: Mixed Weight Service

1 Introduction

- 1.1 Mixed Weight allows you to hand over Large Letters of different weight bands within a Container at an Inward Mail Centre.
- 1.2 You may use this presentation option if you have agreed to Schedule 5, Part 1: Mixed Weight of the Contract and completed the implementation timeline with us successfully. Your Access Account Director will be able to advise of the timescales involved.

2 Presentation

- 2.1 Mixed Weight is a presentation option for Large Letters only, unless you are posting Catalogues (in which case the Mixed Weight rules within Appendix H will apply to those Catalogues).
- 2.2 Large Letters (including General Large Letters) must be sorted by you to the Access 70 sortation option.
- 2.3 You shall ensure that each Mixed Weight Posting on any Working Day shall comprise not less than 4000 Mailing Items per Service qualifying as Mixed Weight.
- 2.4 As is the case for all other Services, Mixed Weight may not be used for handing over different Formats in any one Container.
- 2.5 You must test the upload of your Mixed Weight data via DocketHUB prior to your first Mixed Weight Posting.

3 Container labels

- 3.1 You must include an additional identifier (**MW**) on the Container CFL (see Figure 28), so that the Inward Mail Centre can identify the Posting is Mixed Weight.
- 3.2 The unique Container ID on the Container label must contain no more than 12 characters
- 3.3 If your Mailing Items arrive in York Containers, there is also a requirement to include 'Mixed Weight' on the York cards (see Figure 29).
- 3.4 All other labelling requirements set out at Section 5 must be followed.

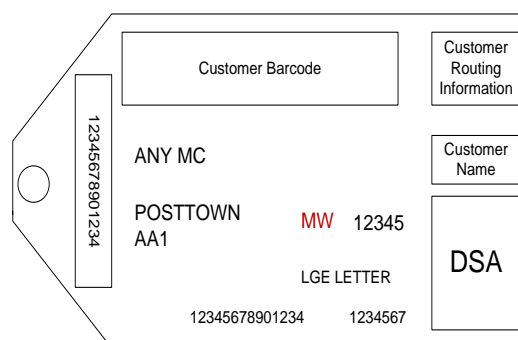

Figure 28: Mixed Weight bag label

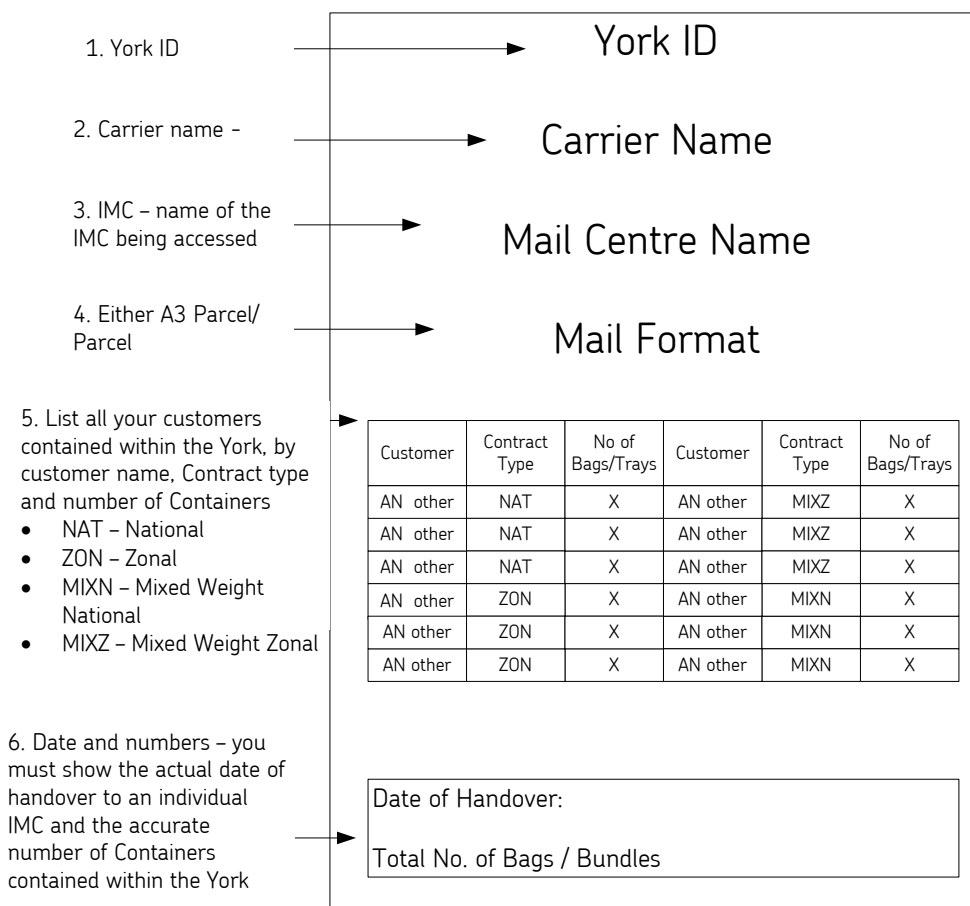

Figure 29: Mixed Weight York label

4 Forecast

4.1 You must upload a 7-Working Day forecast of Mixed Weight Postings into DocketHub (see Section 8.2).

5 Documentation

5.1 The Manifest enables you to declare both Mixed Weight and non-Mixed Weight Containers. An example of the Manifest is shown in Figure 17.

5.2 You must declare on the Manifest the total number of Large Letters by weight band (see Figure 30).

5.3 The weight band indicators to be used on the Manifest are as follows:

WEIGHT BAND	WEIGHT	PRICING
WB1 (weight band 1)	Mailing Items weighing no more than 100g.	All Mailing Items falling within this weight band will be priced accordingly.
WB2 (weight band 2)	Mailing Items weighing more than 100g and no more than 250g.	All Mailing Items falling within this weight band will be priced accordingly.
WB2 (weight band 3)	Mailing Items weighing more than 250g and no more than 750g.	Mailing Items are priced in 1g increments at the average weight of all the items falling within this weight band.

5.4 If you have a Contract that permits you to post under a National and the Zonal Price Plans, you must upload your data for Mixed Weight Postings under each separate Price Plan to a discrete Mixed Weight Manifest relevant to each Price Plan.

Appendix E: Mixing Supply Chain IDs (SCIDs)

1 Introduction

- 1.1 Mixing SCIDs allows you to mix Mailmark Mailing Items belonging to different SCIDs into Containers for handover at an Inward Mail Centre.
- 1.2 You may use this presentation option if you have signed up to Schedule 5, Part 4: Mixing Supply Chain IDs of the Contract.

2 System changes

- 2.1 Before you can hand over Mixed SCID Containers to us you must, at your own cost, undertake all systems and procedural changes required to enable you to meet the Mixing SCIDs Specification and notify us in writing once you have done this. Once we have confirmed that you have made all such we will notify you of the Mixing SCIDs Start Date.

3 Documentation

- 3.1 For each Mixed SCID Container, you must declare on the Posting Docket the following information:
 - a. code number "999999999" in the SCID field (**Mixed SCID Code**);
 - b. code number "999999999" in the eManifest ID field (Mixed eManifest ID Code).
- 3.2 If you choose to use UCIDs to identify your discrete postings, a discrete UCID pertaining to the Posting Entity in the UCID field (**Mixed UCID**).
- 3.3 You must declare the Container ID in spare field 10 of the eManifest for Mailing Items that you put into Mixed SCID Containers.

4 Advertising Mail and Partially Addressed Postings

- 4.1 For Royal Mail Advertising Mail Postings or Partially Addressed Postings, where you, or the Customer Entity or Originating Posting Customer, as the case may be, has not exercised the Data Opt Out, you must apply a Mail Reference for the applicable Advertising Mail Posting or Partially Addressed Postings, and you must use only the Mailmark eManifest to denote this. For clarity, the Posting Docket must not be used by you to provide the Mail Reference for a Mixed SCID Container.
- 4.2 For Mixed SCID Containers of Advertising Mail or Partially Addressed Mail, each seed/sample of mailing pack design which you submit to us must reference the Mixed UCID pertaining to the Mixed SCID Containers.

5 Compliance

- 5.1 For Mixed SCID Containers containing Mailmark Mailing Items from different Supply Chains, you must ensure that all Mailmark Mailing Items in each Mixed SCID Container belong to the same Mailmark credit account.
- 5.2 You shall not reuse a Container ID more than once in a 90-day period, commencing from the date you include that Container ID in the eManifest.
- 5.3 If a Mixed SCID Container which you have identified on the eManifest is not handed over to us on the day the eManifest is confirmed, the Container ID for the Mailing Items in that Mixed SCID Container must not be changed if the Mailing Items are to be resubmitted within 5 days of the eManifest being confirmed.

Appendix F: Digital Stamp Indicator

1 Introduction

1.1 This appendix sets out the Digital Stamp Design Specification which you must meet when using a Digital Stamp Indicator on Mailing Items.

1.2 You may use Digital Stamp Indicators if you have agreed to Schedule 5, Part 5: Digital Stamps of the Contract. It is the responsibility of your supply chain members to ensure they have checked with you as to whether you have agreed to Schedule 5, Part 5: Digital Stamps of the Contract.

1.3 Digital Stamp Indicator specified for:

- a. Letters must only be used for Mailing Items to be posted as Letters; and
- b. Large Letters must only be used for Mailing Items to be posted as Large Letters.

2 The Digital Stamp designs

2.1 You have a choice of Digital Stamp Indicator to use. For each Digital Stamp Indicator, we provide artwork comprising the stamp image, the cancellation marks and the Royal Mail cruciform and 'Delivered By' text. You will need to add the Access Licence Number for the relevant Access Contract. Please see Paragraph 3 below for a list of available Digital Stamp Indicia and stamp artwork dimensions.

2.2 New Digital Stamp Indicators will be made available from time to time and we will notify you as and when these new Indicators are issued. Your print supplier will need to gain approval in order to be authorised to print a new Digital Stamp Indicator.

2.3 To request "Digital Stamp Artwork" please contact accessdigitalstamp@royalmail.com.

3 Mandatory design requirements

3.1 Artwork:

- a. Only Digital Stamp artwork issued by us can be used.
- b. You must ensure that the correct Access Licence Number (C9 number) relevant to the Access Contract you use for the Posting is added to the artwork in the position detailed in Figure 31 and Figure 32 below.
- c. Font and size for the Access Licence Number is Helvetica Neue Regular 10pt which must be printed in black.
- d. Artwork must be produced in full colour to 300dpi for printing with the colour remaining consistent with the artwork issued.
- e. Artwork must meet the exact dimensions of the Digital Stamp artwork (see Figure 31 below).

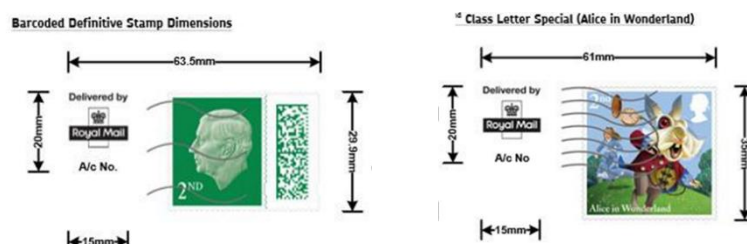

Figure 31: Access License Number positioning and dimension requirements for Digital Stamp Indicators

3.2 Envelope material properties:

- a. To ensure accurate colour reproduction of the Digital Stamp artwork, the envelope must be manufactured from a white, coated material. If you intend to print an overall colour to the envelope, the Digital Stamp Indicator must be printed onto a white background and contain a white border which provides a 5mm clear zone free from print. The envelope material must have the following properties:
 - i. The white substrate must have a brightness value of a minimum of 75% when measured using BS EN ISO 2470 Measurement of Diffuse Blue Reflectance Factor (ISO Brightness) of Paper and Board; and
 - ii. the white substrate must have an opacity value of a minimum of 75% when measured using BS EN 2471 Opacity (Paper Backing) of Paper and Board by the Defuse Reflectance Method.

3.3 Dimensions, layout and positioning:

- a. The following requirements must be met:

	Digital Stamp
Stamp position from right hand edge of envelope (mm)	5 (+/-2mm)
Stamp position from TOP of envelope (mm)	5 (+/-2mm)
Font for Access Licence Number (printed in black)	Helvetica Neue Regular
Font size for Access Licence Number (mm)	10pt
White border clear zone around the extremities of the Digital Stamp Indicator	5mm
Print DPI	300 x 300
The maximum skew for the whole Digital Stamp Indicator from the horizontal axis	± 3°

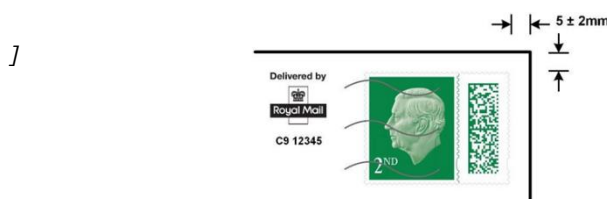

Figure 32: Digital Stamp Indicator layout and positioning

- b. If you want to add the Customer Access Indicator to the Mailing Item, you must position it to the left of the Digital Stamp Indicator and ensure the 5mm white border clear zone is maintained.

4 Mailmark

- 4.1 Digital Stamp Indicators must only be used on Mailing Items posted under Royal Mail Mailmark® and as such, your items need to meet the Royal Mail Mailmark® specification (see Appendix M).

5 Customer and print supplier approval process

- 5.1 If you are using a print supplier, prior to using a Digital Stamp Indicator for the first time, you should check that your print supplier's production site has been approved by us for printing of that Digital Stamp Indicator. You can check this at www.royalmailwholesale.com/digital-stamp-indicia.

5.2 If your print supplier has not yet been approved for producing the Digital Stamp Indicator, they need to follow the process below:

- a. Contact accessdigitalstamp@royalmail.com who will outline all steps of the process and work with you and/or your print supplier to obtain approval;
- b. The Digital Stamp Indicator artwork designs and the Digital Stamp approval application form is available on request from accessdigitalstamp@royalmail.com;
- c. From the artwork and specification, your print supplier will need to produce a copy of each of the Digital Stamp Indicators intended to be used:
 - i. the classic second class letter stamp design;
 - ii. the classic second class large letter stamp design; and
 - iii. each Special Stamp image.
- d. Epson prints are acceptable; however, the envelope material properties of this specification must be met to obtain reproduction of the image to the satisfactory standard.
- e. The physical copies of the Digital Stamp Indicator designs need to be sent, along with the Digital Stamp approval application form, to us at the following address for approval:

RM Digital Stamp Approval Team
Royal Mail Wholesale
185 Farringdon Road
LONDON
EC1A 1AA
- f. We shall notify our approval to you and the print supplier. If approval is not given, we will advise you and the print supplier about the issues we identified. Revised copies will have to be submitted to us if you would like us to consider your application for approval again.
- g. Once the print supplier's production site has been approved we will add their details to www.royalmailwholesale.com/digital-stamp-indicia. The published details are: supplier name; approval site; contact details; and approved Digital Stamp Indicia. Print suppliers must specify to us on the Digital Stamp approval application form if they do not want their details published on the website.
- h. Following approval, the print supplier is permitted to use the approved Digital Stamp Indicator on all Royal Mail Mailmark® Mailing Items printed at the approved print production site provided that the terms set out in the approval application form and the Digital Stamp Design Specification continue to be met. Royal Mail may issue additional Digital Stamp Indicator or amend existing Digital Stamp Indicator from time to time. For the avoidance of doubt, there is no requirement for an approved print supplier's site to gain further approvals unless the print supplier wants to use a new Digital Stamp Indicator.

Print suppliers are able to seek approval independent of a posting customer.

6 Providing Seeds

6.1 You must send us a seed/ sample of each Posting you send using a Digital Stamp Indicator so we can verify that the Digital Stamp Design Specification is being met on an ongoing basis. If you are unable to provide us with a seed/ sample, we will accept a sample item from each Posting using the Digital Stamp Indicator (to be sent to us on the first day of posting). Customer UCIDs must be included within the seed address.

6.2 The address for seeds/ samples is:

RM Digital Stamp Sample [Insert Customer UCID]
RM Digital Stamp Team
PO Box 73733
LONDON
EC1P 1JX.

Appendix G: Advertising Mail

1 Introduction

1.1 This appendix sets out the specification requirements you must adhere to when posting Mailing Items using the Advertising Mail Service, in addition to the requirements you must comply with as set out in Schedule 4, Part 1: Royal Mail Advertising Mail.

2 Qualification

2.1 To qualify as Advertising Mail you shall ensure:

- a. that Mailing Items:
 - i. consist of a largely uniform message to all addressees of the Advertising Mail Posting;
 - ii. have the purpose of promoting the sale or use of products or services, or to encourage contribution to or support of a cause; and
- b. that each Advertising Mail Posting:
 - i. contains a minimum 4000 Mailing Items in a Posting; and
 - ii. is assigned a UCID pertaining to the Originating Customer or Customer Entity, to be used in line with this Contract. (For clarity, you may not mix Mailing Items with different mailing pack designs in Containers assigned to a single UCID). For more information about UCIDs see Section 4.5(b) of this User Guide.

3 Data specification

3.1 You must:

- a. where data is not from a consent based file, have a documented procedure in place that is used to suppress customer and prospect data against the Mailing Preference Service (MPS), including MPS Deceased, and each address list used by you to prepare your Advertising Mail must on each occasion you hand over Advertising Mail be run against these files not more than 30 days before the Mailing Item that uses the data is delivered to the recipient (and for the purpose of this specification, all references to the term 'delivered' in this section shall mean 'posted' as notified by you to us);
- b. keep and maintain an internal suppression file to ensure that opt-outs are properly logged, and each Advertising Mail Posting must be run against these files 30 days or less before the Mailing Item that uses the data is delivered to the recipient; and
- c. ensure that at least 90 per cent of Mailing Items are fully and accurately addressed and postcoded in line with our Postcode Address File (PAF®).

3.2 The Data Opt Out, and both parties responsibilities in relation to the Data Opt Out, are explained further in Schedule 4, Part 1: Royal Mail Advertising Mail.

4 Samples/ Seeds of Mailing Items

4.1 For each Advertising Mail Posting you must provide us with a sample of the Mailing Item to be used prior to posting or include us as a seed in the Posting to verify it meets the Advertising Mail specification.

The sample/seed must be an exact reproduction of the Mailing Items to be posted in terms of both envelopes used and contents enclosed and must clearly include the following information:

- a. the relevant UCID; and
- b. unless the Data Opt Out has been exercised, the Mail Reference.

4.2 The Sample/Seed must be sent to the following address:

RM Sample
Royal Mail Wholesale *[immediately followed by the relevant UCID number, e.g. 12345 and the Mail Reference]*
PO Box 72662
London
E1W 9LD

5 Presentation

- 5.1 You must ensure that Mailing Items are presented in trays or bags that exclusively contain Advertising Mail. If Mailing Items are to be presented unbagged you must meet the requirements set out in Section 4.3(e) of this User Guide, and bundles must exclusively contain Advertising Mail only.
- 5.2 An Advertising Mail Posting may be presented in Yorks with other UCID Postings or Consolidated Postings, as long as you use Yorks in line with this Contract.
- 5.3 We want to provide you with the best possible service when using Advertising Mail, so mailings are received by customers in great condition. However, mail is a physical medium and occasionally indentations or marking of mail may occur as it passes through machinery. This applies particularly with Unwrapped mail (i.e. of postcard type design) that has been produced through digital print technology. To minimise issues we recommend that digitally printed mail items are wrapped, or an ultra violet (UV) or water based gloss coating applied to the non-address side of the finished piece. These coatings enhance wear resistance. Mail produced on lithograph presses is less susceptible to this type of marking.

6 Container labels

- 6.1 Each Container containing Advertising Mail must be labelled by you using the labels we provide, clearly indicating that the contents are Advertising Mail.
- 6.2 All other labelling requirements set out at Section 5 must be followed.

7 Product codes

- 7.1 You must use the Advertising Mail Service product codes when posting Advertising Mail, as specified in the Royal Mail Service List which lists all Access Services and their corresponding DocketHUB and SAP codes.
- 7.2 You can access the Service List via DocketHUB in the 'Reports' section under the 'Service Status List' category.

Appendix H: Advertising Mail Catalogue

1 Introduction

1.1 This appendix sets out the specification requirements you must adhere to when posting Catalogues (as defined in the 'Qualification' section of this appendix) in addition to the requirements you must comply with as set out in Schedule 4, Part 1: Royal Mail Advertising Mail.

1.2 For clarity, Catalogues are a variant of the Royal Mail Advertising Mail Service.

2 Qualification

2.2 A Mailing Item will constitute a "Catalogue" if the Mailing Item is Advertising Mail and we determine that:

- a. the Mailing Item comprises a list of goods and/or services together with a description, image and price;
- b. the editorial and other content of the Mailing Item is minimal; and
- c. the content of the Mailing Item enables sales orders to be taken on such goods and/or services (including auctioned goods and services) directly from the page at the prices listed.

3 Sortation, Formats and weight options

3.1 The Catalogue option is for items that are sorted to Access 70 selections.

3.2 The maximum size dimensions and weights applicable to Mailing Items that are Catalogues are set out in Figure 33 below:

	<i>max mm</i>	<i>max mm</i>	<i>max mm</i>	<i>max g</i>	<i>Weight Band</i>
Format	Length	Width	Depth	Weight	
Access 70 Letter	240	165	5	Up to 100	WB1
Access 70 Letter	240	165	5	101 – 150	WB2
Access 70 Large Letter	353	250	25	Up to 100	WB1
Access 70 Large Letter	353	250	25	101 – 250	WB2
Access 70 Large Letter	353	250	25	251 – 750	WB3

Figure 33: Catalogue sortation, Format and weight options

3.3 All Letter format items and Large Letter format items must be sorted into weight bands.

4 Mixed Weight

4.1 Mixed Weight is a presentation option for Large Letters and, for the purposes of the Catalogue option only, for Letters but only to the extent that the Letters constitute Catalogues. If you are posting Letters as Catalogues using Mixed Weight you must inform your Account Director in advance of commencing posting.

4.2 When declaring Catalogues as Mixed Weight on the Manifest, the weight band indicators to be used are those specified in Figure 33 above. For all other types of Mailing Items, you must declare the item weights using the weight bands detailed at Appendix D of this User Guide.

5 Samples/ Seeds of Mailing Items

5.1 You must send us a seed/sample of your Catalogue mailing in line with the Advertising Mail terms and conditions of Schedule 4, Part 1: Royal Mail Advertising Mail of the Contract and Appendix F of this User Guide.

6 Container labels

6.1 It is a requirement to identify the bags and trays containing Catalogue mailings. You must use the abbreviation 'CAT' and place it above the Customer Type in the Customer Indicator Box of the bag label or tray label. See example below.

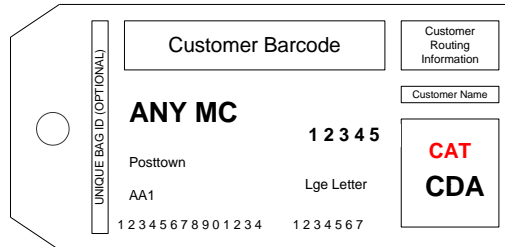

Figure 34: Bag label for Advertising Mail Catalogue mailings:

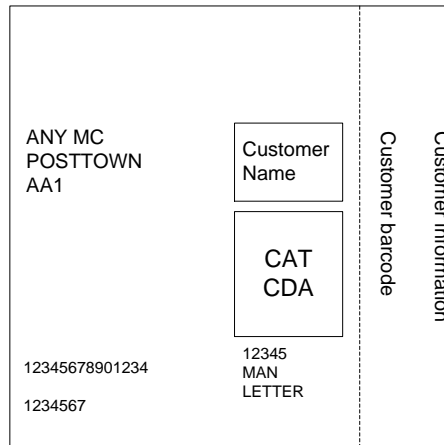

Figure 35: Tray label for Advertising Mail Catalogue mailings:

7 Product Codes

7.1 You must use the Catalogue mail product codes when posting Catalogue mailings, as specified in the Royal Mail Service List which lists all Access Services and their corresponding DocketHUB and SAP codes.

7.2 You can access the Service List via DocketHUB in the 'Reports' section under the 'Service Status List' category.

Appendix I: Partially Addressed Mail

1 Introduction

1.1 This appendix sets out the specification requirements you must adhere to when posting Mailing Items using the Partially Addressed Mail Service, in addition to the requirements you must comply with as set out in Schedule 4, Part 1: Royal Mail Partially Addressed Mail.

2 Qualification

2.1 To qualify as Partially Addressed Mail you shall ensure:

- a. that Mailing Items:
 - i. consist of a largely uniform message to all addressees of the Partially Addressed Mail Posting;
 - ii. have the purpose of promoting the sale or use of products or services, or to encourage contribution to or support of a cause;
 - iii. do not contain any personally identifiable information;
 - iv. are not addressed to a named person; and
- b. that each Partially Addressed Posting:
 - i. contains a minimum 10,000 Mailing Items in a Posting; and
 - ii. is assigned a UCID pertaining to the Originating Customer or Customer Entity, to be used in line with this Contract. (For clarity, you may not mix Mailing Items with different mailing pack designs in Containers assigned to a single UCID). For more information about UCIDs see Section 4.5(b) of this User Guide.

3 Sortation, Formats and processing options

3.1 The Partially Addressed Mail Service can be used with the following sortation level, Formats and processing options:

Sortation level	Access 70
Format	Letter or Large Letter
Processing option	Royal Mail Mailmark

4 Data specification

4.1 To qualify for Partially Addressed Mail you must ensure that all Mailing Items in each Partially Addressed Mail Posting are posted to each household in a targeted postcode except:

- a. any household where habitants are an existing customer of the Originating Customer or Customer Entity; and
- b. any household where a habitant has opted out from receiving such Mailing Items; and
- c. any postcode that contains only a single household; and
- d. any household or address that itself contains personal data (for example, where habitants' names form part of the address).

- 4.2 As part of ensuring your compliance with the requirements set out in Paragraph 4.1 above (and without prejudice to the obligations in that Paragraph 4.1, you will:
- a. use a version of PAF that removes any postcode that contains only a single household and any household that contains personal data;
 - b. maintain a documented internal procedure for suppressing customer and prospect data. You must prepare your suppression files within 30 days or less before the Mailing Item that uses the data is delivered to the recipient;
 - c. keep and maintain an internal suppression file to ensure that opt-outs are properly logged, and each Partially Addressed Mail Posting must be run against these files 30 days or less before the Mailing Item that uses the data is delivered to the recipient;
 - d. keep and maintain each suppression file for a minimum of two years from the date of its creation; and
 - e. at your option, use the MPS file to suppress the data at a household level.
- 4.3 You shall ensure that you have and maintain all rights, consents and permissions required in order to carry out such data suppression activities and any other activities required in order to ensure that you comply with the terms of this Paragraph 4.
- 4.4 The Data Opt Out, and both parties responsibilities in relation to the Data Opt Out, are explained further in Schedule 4, Part 1: Royal Mail Partially Addressed Mail.

5 Partially Addressed declaration

- 5.1 You may opt to include the "declaration" message on each Mailing Item that reads, "No personal data about recipients has been used in the creation of this mailing" (the "**Declaration**").
- 5.2 If you do elect to include the Declaration, it must be positioned either:
- a. in any location on the first page of the inner mailpiece (where applicable);
 - b. in any location on the back face of the Mailing Items; or,
 - c. on the front face of the Mailing Items (being the face of the Mailing Item with the address).
- 5.3 If the address is to be placed on the front face of the Mailing Item, the Declaration must also:
- a. not be positioned in Mailing Item clear zones, as specified in this User Guide;
 - b. be printed using black Arial 10pt bold font with normal line spacing (or white text where a dark envelope is used) and be centre justified;
 - c. where a Return Address is also included on the front of the Mailing Item, be placed in the location shown in Figure 36 below, or, where a Return Address is not included on the front of the Mailing Item, be placed in the location shown in Figure 37 below:

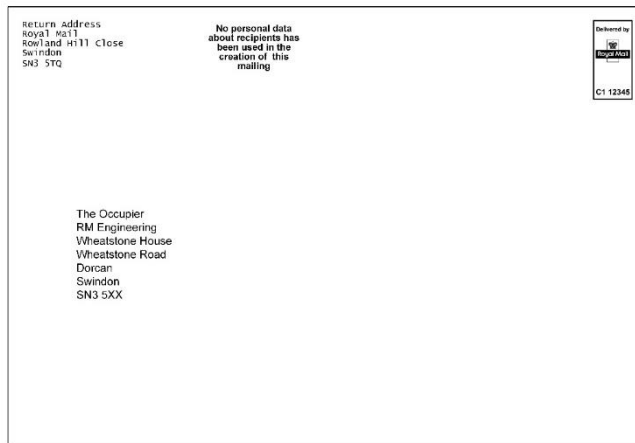

Figure 36: Mailing Item bearing Declaration and return address on the front



Figure 37: Mailing Item bearing Declaration but no return address on the front

- d. or, in the case of postcards, the Declaration may, as an alternative to Figure 36 and Figure 37 above, be printed linear format, in any readable font, on the vertical left edge of the Mailing Items. Figure 38 below illustrates the two alternatives for the position of the Declaration for postcards:

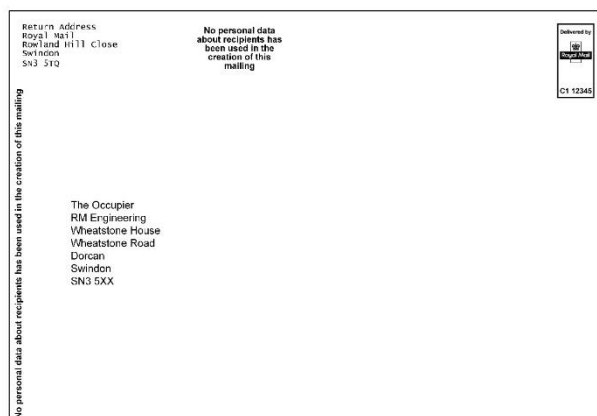

Figure 38: For postcards only, the Declaration location can be placed in either of the positions shown

6 Samples/ Seeds of Mailing Items

6.1 For each Partially Addressed Posting you must provide us with a sample of the Mailing Item to be used prior to posting or include us as a seed in the Posting to verify it meets the Partially Addressed Mail

specification. The sample/seed must be an exact reproduction of the Mailing Items to be posted in terms of both envelopes used and contents enclosed and must clearly include the following information:

- a. the relevant UCID; and
- b. unless the Data Opt Out has been exercised, the Mail Reference.

6.2 If you are sending us a seed/sample by post, you must send it to:

PO Box 75218
LONDON
E1W 9PZ

6.3 Alternatively you may send a seed/sample to us in electronic format by submitting a PDF by email to dsacc@royalmail.com (or such other address as we may notify you of from time to time), including the following information:

- a. email title: Partially Addressed Mail Sample for [customer name];
- b. pdf attachment(s) to include front and back of outer and all inner content;
- c. Date of posting;
- d. UCID number;
- e. SCID number; and
- f. eManifest ID.

7 Presentation

7.1 You must ensure that Mailing Items are presented in trays or bags that exclusively contain Partially Addressed Mail. If Mailing Items are to be presented unbagged you must meet the requirements set out in Section 4.3(e) of this User Guide, and bundles must exclusively contain Partially Addressed Mail only.

7.2 A Partially Addressed Mail Posting may be presented in Yorks with other UCID Postings or Consolidated Postings, as long as you use Yorks in line with this Contract.

8 Container labels

8.1 It is a requirement to identify the bags and trays containing Partially Addressed Mailings. You must use the abbreviation 'PARTIAL' and place it above the Customer Type in the Customer Indicator Box of the bag label or tray label. See example below:

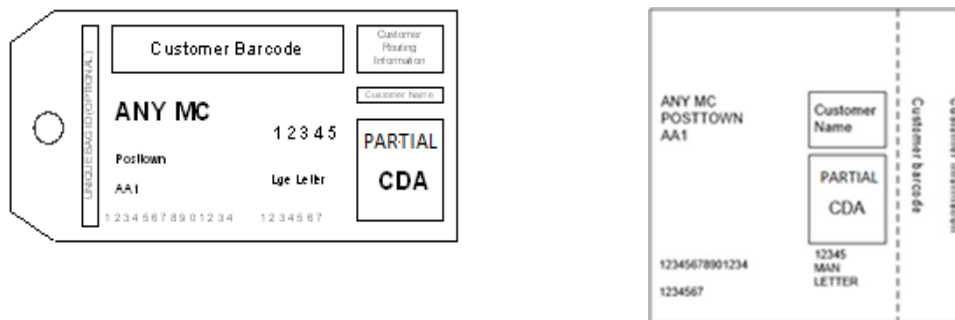

Figure 39: Bag and Tray label examples for Partially Addressed Mail

8.2 All other labelling requirements set out at Section 5 must be followed.

9 Product codes

- 9.1 You must use the Partially Addressed Mail Service product codes when posting Partially Addressed Mail, as specified in the Royal Mail Service List which lists all Access Services and their corresponding DocketHUB and SAP codes.
- 9.2 You can access the Service List via DocketHUB in the 'Reports' section under the 'Service Status List' category.

Appendix J: Business Mail Large Letter

1 Introduction

1.1 This appendix sets out the specification requirements you must adhere to when posting Mailing Items using the Business Mail Large Letter Service, in addition to the requirements you must comply with as set out in Schedule 4, Part 2: Royal Mail Business Mail Large Letter.

2 Qualification

2.1 To qualify as Business Mail Large Letters you shall ensure that Mailing Items:

- a. have dimensions which meet the specifications for a Large Letter as set out in the User Guide;
- b. are not Goods Fulfilment Large Letters and, for clarity, Business Mail Large Letter Permitted Items shall not constitute Goods Fulfilment Large Letters for these purposes;
- c. do not comprise of packaging which is Prohibited Packaging.

3 Presentation

3.1 You must ensure that Mailing Items are presented in trays or bags that exclusively contain Business Mail Large Letters.

3.2 Business Mail Large Letters may be presented in Yorks with other UCID Postings or Consolidated Postings, as long as you use Yorks in line with this Contract.

4 Container labels

4.1 Each Container containing Business Mail Large Letters must be labelled by you using the labels we provide, clearly indicating that the contents are Business Mail Large Letters.

4.2 All other labelling requirements set out at Section 5 must be followed.

5 Product codes

5.1 You must use the Business Mail Large Letter Service product codes when posting Business Mail Large Letters, as specified in the Royal Mail Service List which lists all Access Services and their corresponding DocketHUB and SAP codes.

5.2 You can access the Service List via DocketHUB in the 'Reports' section under the 'Service Status List' category.

Appendix K: Magazine Subscription Mail

1 Introduction

1.1 This appendix sets out the specification requirements you must adhere to when posting Mailing Items using the Magazine Subscription Mail Service, in addition to the requirements you must comply with as set out in Schedule 4, Part 3: Royal Mail Magazine Subscription Mail.

2 Qualification

2.1 To qualify as Magazine Subscription Mail you shall ensure:

- a. that Mailing Items:
 - i. have dimensions which meet the specifications for a Large Letter as set out in this User Guide;
 - ii. comprise at least thirty per cent of editorial content. Editorial content does not include advertising material or data; or any information relating to a product or service, such as pricing information or product descriptions, which relate to either the publisher of the Title, the owner of the Title or a third party; and
 - iii. show the Title, and at least the date of issue, or the issue number on the front cover.

3 Registering the Title

3.1 Before you handover Magazine Subscription Mail to us you must:

- a. register each Title with us by completing the application form on the Website including, the name of the Title which is to be sent as Magazine Subscription Mail, the name of the Title's publisher and the Supply Chain ID you will use for each Mailmark Mailing; and
- b. provide us with a sample of the Title in accordance with this section below. The sample must be an exact reproduction of the Title to be posted in terms of both outers used, front covers and contents enclosed.

3.2 The registration form can be emailed to dsacc@royalmail.com and sample must be sent to the following address:

RM Sample (Magazine Subscription Mail)
Royal Mail Wholesale [immediately followed by the relevant Mailmark SCID number],
2nd Floor 206
Whitechapel Rd
London
E1 1AA

3.3 We will confirm in writing to you whether the Title is eligible for the Magazine Subscription Service and you may commence your Magazine Subscription Mail Postings of that Title from the date of our notification.

4 Sortation, Formats and processing options

4.1 The Magazine Subscription Mail Service can be used with the following sortation level, Formats and processing options:

Sortation level	Access 70
Format	Large Letter
Processing option	<p>For Magazine Subscription Mailing Items which are up to 10mm thickness you must use Royal Mail Mailmark (and comply with the specification requirements set out in Schedule 8, Part 1: Royal Mail Mailmark), or handover the items as Manual Items; or</p> <p>For Magazine Subscription Mailing Items which are more than 10mm and less than 25mm thickness you must handover the items as Manual Items.</p>

5 Presentation

5.1 You must ensure that each Container you use to hand over Magazine Subscription Mail to us under the Contract must contain only Magazine Subscription Mail of the same Title.

6 Container labels

6.1 Each Container containing Magazine Subscription Mail must be labelled by you using the labels we provide, clearly indicating that the contents are Magazine Subscription Mail.

6.2 All other labelling requirements set out at Section 5 of this User Guide must be followed.

7 Product codes

7.1 You must use the Magazine Subscription Mail Service product codes when posting Magazine Subscription Mail, as specified in the Royal Mail Service List which lists all Access Services and their corresponding DocketHUB and SAP codes.

7.2 You can access the Service List via DocketHUB in the 'Reports' section under the 'Service Status List' category.

8 Documentation

8.1 When posting using Royal Mail Mailmark, you must reference the Title name in the "Campaign Name" field of the Mailmark eManifest each time you submit a Magazine Subscription Mail Posting to us.

Appendix L: OCR® (Discontinued)

The OCR service has been discontinued effective from 1 April 2024. Introduction

Appendix M: Royal Mail Mailmark®

1 Introduction

- 1.1 Royal Mail Mailmark® is the application, through the use of software, of a 2d or 4-state barcode to each of your Mailing Items. The use of Mailmark barcode enables our automation to read each Mailing Item and, through reporting data, give you performance measurement at item and posting level.
- 1.2 Refer to Section 1 of this User Guide to find out more about the Services which Mailmark may be used with.
- 1.3 This appendix sets out physical design, Indicum, addressing, barcoding and other Royal Mail Mailmark specifications that are required when posting Mailing Items using Mailmark.
- 1.4 If you wish to use Mailmark to send poll cards, in addition to the requirements set out in this appendix, you are also required to meet the specification set out in Paragraphs 5 to 13 of Appendix P of this User Guide
- 1.5 The Mailmark specification is designed to ensure that Royal Mail Letter and Large Letter processing machines can process and read Letters and Large Letters effectively at high speed, without the need for manual or other intervention. Each specification requirement set out in this Appendix M has been assessed and is categorised as either 'Mandatory' (M), or 'Recommended High Risk' (H) or 'Recommended Low Risk (L)':
 - a. Mailing Items that fail to meet the 'Mandatory' requirements are regarded as unmachineable and are very likely to have Adjustments applied.
 - b. Mailing Items which fail to meet the requirements that are identified as 'Recommended - High Risk' have a higher likelihood of performing poorly through our processing machines. Mailing Items that fail to meet these requirements are more likely to have Adjustments applied and may become damaged in our processing machines.
 - c. Mailing Items which fail to meet the requirements that are identified as 'Recommended - Low Risk', may perform poorly through our processing machines. However, the risk is lower than that posed by failure to meet the 'Recommended High Risk' specifications and there is less chance of the Mailing Items being damaged or Adjustments being applied.

2 Setting up with Mailmark

- 2.1 **Sign the Royal Mail Mailmark® Schedule.** Prior to the first handover of any Mailmark Mailing, you will need to sign the Royal Mail Mailmark® Schedule which details the terms and conditions under which the Mailmark option is offered. You are also required to accept the Royal Mail Mailmark Participant Terms and Conditions® (www.royalmailwholesale.com/royal-mail-mailmark) to become a Participant in a Supply Chain, and you acknowledge that before you can use the Mailmark option each of the Mail Originator, Mail Producer, Carrier and Bill Payer in your Supply Chain will need to have accepted the Participant Terms and Conditions to become a Participant.

If you are wishing to use Mailmark Direct Data, a separate contract is required. The use of Mailmark Direct Data and whether it meets your needs can be discussed with your Account Director prior to requesting this.

- 2.2 **Complete the implementation activities including setting up your Participant and Supply Chain IDs.** Our Mailmark team will be able to guide you through the Mailmark option implementation timeline and actions required.
- 2.3 **Set up your systems.** One of the benefits of Mailmark is the provision of data analysis and consignment level performance reporting. To take advantage of this information it is necessary for you to upload your Docket via DocketHUB and to also provide additional mailing data in the form of an eManifest via our Web service, the eManifest Handling System (eMHS). Failure to upload data correctly, and on time, will affect your reporting and may result in Adjustments if your Mailing Items cannot be

reconciled with the required data. A test eMHS system is available for your use and access can be arranged through our Mailmark team.

- 2.4 **Go through the optional accreditation.** The Mailmark option offers the benefit of being able to assess the performance of your Mailing Items. There is therefore no need for an upfront accreditation check of your Mailing Item design or address, Postcode and Delivery Point Suffix (DPS) accuracy. However, if you wish any 'peace of mind' checks done on your physical Mailing Items please contact your Access Account Manager. These checks include barcode quality checks, pack design and barcode location and machine sorted letter tests. You need to be able to create and apply Mailmark barcodes and you must be able to upload eManifests into eMHS. If you would like to check that you can do so successfully please contact your Account Director or the Mailmark team for support.

3 Polywrapped, paperwrapped and unwrapped Mailmark Mailing Items

- 3.1 If you wish to apply a Mailmark barcode to Letter format Mailing Items that are polywrapped, unwrapped (naked) or not sealed you can do so provided that you present, declare and pay for the items as Large Letters.
- 3.2 When using an outer wrapping to contain Mailing Item contents (e.g. polywrap for Large Letters or paperwrap for Letter and Large Letters), the dimensions permitted apply to the complete Mailing Item, including the outer wrapping and the contents. (For Mailing Items sent using a non-machineable service, the dimensions and Format are measured against the of the insert if the outer can be easily folded.)

4 Useful Mailmark guideline and technical documents

- 4.1 We have created a number of useful guidelines and technical documents which you will need to refer to as they will provide you with details and instructions on:
- a. how to create your Mailmark barcode;
 - b. how to ensure your systems correctly interface with the eMHS;
 - c. how to create a 4-state barcode and barcode options;
 - d. how to encode and decode 4-state barcodes;
 - e. how to download Mailmark Direct Data;
 - f. the technical specification for Mailmark Direct Data files;
 - g. PDF report user guide and;
 - h. Mailmark Adjustments.
- 4.2 You can find the guidelines and technical documents at www.royalmailwholesale.com/royal-mail-mailmark.

5 Sortation

- 5.1 Mailmark must be used with the Access 70 or 48-Way Sort sortation option.

6 Mailmark Barcode requirements

- 6.1 You must ensure each Mailing Item within a Mailmark Mailing:
- a. has a Mailmark Barcode printed on it in addition to any other marks that are required for the Access 70 Mailing Item in question;
 - b. has a Mailmark Barcode printed on it in a manner and location and in accordance with the specifications, as set out in the Mailmark Letters and Large Letters specification below; and
 - c. has, added to the postcode field in the Mailmark Barcode and the eManifest, either:
 - i. the Postcode which the Mailing Item is destined for; or
 - ii. a default postcode (see Paragraph 15 (Default Postcode option) below).

7 Mailmark Letters specification

7.1 You can view the full Mailmark Letters specification [here](#). You will also find the One Piece and Wrap Letter Mailers specification, and Perforated Letter Mailers specification within this document.

(Note: For the avoidance of doubt the linked Mailmark Letters specification document and the figures within form part of this User Guide).

8 Mailmark Large Letters Specification

8.1 You can view the full Mailmark Large Letters specification [here](#).

(Note: For the avoidance of doubt the linked Mailmark Large Letters specification document and the figures within form part of this User Guide).

9 Presentation

9.1 You must ensure:

- a. Mailmark Barcode Mailing Items are presented in Containers which all contain exclusively Mailmark Mailing Items. Other than for Advertising Mail Postings, you may mix Mailing Items with different mailing pack designs in a single Container as long as they all belong to the same Service, Format and UCID (but not necessarily Batch) and as long as they appear on the same eManifest;
- b. all Mailing Items within a Container must have the same SCID with the exception of consolidated Mailmark Mailings made up of Mailing Items originally from different Supply Chains, which may have different SCIDs if a Mailmark Overlay Report is provided. A Participant must provide a Mailmark Overlay Report if Mailmark Barcode Mailing Items are not posted as originally expected and are instead put through a consolidation machine to make up a new Mailmark Mailing; and
- c. Advertising Mail Mailmark Barcode Mailing Items submitted as a Batch on the eManifest must only contain Mailing Items of the same pack design. For clarity, you may submit multiple Batches, provided that each Batch contains Mailing Items of the same pack design.

10 Supply Chain IDs

10.1 A Supply Chain ID (SCID) is a unique identifier assigned to each Supply Chain.

10.2 You must use the correct SCID relevant to a Supply Chain. If you use an incorrect SCID then Participants from other Supply Chains may have access to your Reports and/or the wrong Bill Payer may be invoiced and if, due to your incorrect usage of the SCID, we incur any costs, expenses, demands, claims or liabilities in connection with Participants from other Supply Chains accessing your Reports and/or the wrong Bill Payer being invoiced, you agree to indemnify us for those costs, expenses, demands, claims and liabilities.

11 eManifest requirements

11.1 The eManifest is an electronic record of your Mailmark Mailing Items (Letters and Large Letters) posted against a non-transferrable unique SCID on each day. The data within the eManifest, together with the machine processing data validated against it, is used for reporting and the SCID represents the client, Mail Producer, Carrier and Bill Payer for that mailing.

11.2 An eManifest is a mandatory requirement for both 4-state barcode Mailmark Mailings Items and 2D data matrix Mailmark Mailings Items. If you do not upload an eManifest we will see those Mailing Items as we process them and may invoice the Bill Payer for them as unManifested items.

11.3 You must ensure for each Mailmark Mailing a Batch or multiple Batches are submitted to an eManifest via the eManifest Handling System in accordance with this Paragraph 11 and the Mailmark eMHS Implementation Guidelines accessible via our Website. In particular you must ensure:

- a. the address data file is sorted and populated at item level with Mailmark information (Supply Chain, unique item ID, barcode data string etc) through a software solution or in-house mail producer IT systems. This creates a file which can then be uploaded into an eManifest;
- b. you will not insert any words or terms into the free text fields in the eManifest which may appear in the resulting Reports which, in our opinion, damage or may damage our reputation or business or the reputations or businesses of any member of the Royal Mail Group or which may result in any costs, expenses, demands, claims or liability being asserted or assessed against any member of the Royal Mail Group and/or any of their respective directors, officers, employees, agents and/or representatives;
- c. you complete the mandatory fields within the eManifest which are:

Header:

1. *Supply Chain ID (SCID)*
2. *Mail Originator*
3. *Date (the date of the eManifest confirmation and the handover date)*
4. *eManifest status (open, finalised, test)*
5. *eManifest ID*

Detail:

1. *Unique Mailing Item ID*
 2. *Batch ID*
 3. *Address (whilst the full address is recommended, only the postcode and DPS are required. Recipient details must not be included. NOTE: The postcode declared in the eManifest must match the postcode declared in the Mailmark Barcode, for example if you are using the Default Postcode options (see Section 6 above) then the Default Postcode must be declared in the eManifest and Mailmark Barcode))*
 4. *Product attributes (format, weight etc.)*
- d. only one eManifest is uploaded per SCID, per Working Day, to the eManifest Handling System by any of the Participants in the Supply Chain. For clarity, a single eManifest may declare a Mailmark Mailing made up of a single Batch or multiple Batches, or if the same Supply Chain has more than one Mailmark Mailing to be posted on the same day, the eManifest may contain multiple Mailmark Mailings provided that each Mailmark Mailing relates to the same SCID;
 - e. you upload all Mailmark Mailing Items on your Posting Docket. For clarity the Posting Docket that you submit is separate and in addition to the eManifest, unless you are using eManifest Billing (see Appendix Q) in which you are not required to provide a Posting Docket. You must submit the correct eManifest ID and the correct SCID against Container on the Posting Docket using the fields provided for those purposes;
 - f. each Batch has a minimum volume of 4,000 Mailing Items. It is possible to split Batches and submit more than one Batch to make use of reporting by Batch, providing each Batch contains the minimum volume of Mailing Items required;
 - g. Mailmark files, with the individual items for that SCID, for a single day's handover are then uploaded to the eManifest either as a single file or in Batches. This is mandatory for any Mailmark Mailing. If data files are uploaded in Batches, amendments can be made to any Batch until the eManifest been confirmed. At the point of confirmation, no further changes to a Batch can be made;
 - h. when all the Batches or single file for the SCID have been uploaded, the eManifest is submitted and confirmed. Once an eManifest is confirmed, no further changes can be made to the uploaded files;
 - i. each eManifest will have a unique eManifest ID. This eManifest ID and SCID must be included in the relevant fields on the Manifest. The eManifest ID must be included on your Posting Docket or an administration charge may be applied.

11.4 When you must submit your eManifest:

- a. An eManifest can be created up to 28 days prior to a handover date;

- b. The eManifest must be confirmed the day prior to the Handover Day;
- c. The deadline for confirming Network Access Item eManifests is configured to 23:30 on the submission date specified in the eManifest. At this time, any remaining open Item eManifests will be automatically confirmed and closed to further Batch submissions;
- d. The deadline for confirming Consolidator Item eManifests is configured to 05:00 on the submission date specified in the eManifest. At this time, any remaining open Item eManifests will be automatically confirmed and closed to further Batch submissions.

11.5 When you must hand over Mailmark Mailing Items:

- a. Mailmark Mailing Items should be handed over on the day stated as the handover date on the eManifest. Please note that if Mailing Items are handed over 5 or more working days after the eManifest is confirmed the Bill Payer may be invoiced twice and may have Adjustments applied.

11.6 Failure to create an eManifest:

- a. If an eManifest is not created and uploaded in accordance with this Paragraph 11, we may process your Mailing Items and apply Adjustments.
- b. Please note that without an eManifest we cannot provide reporting.

12 Posting Docket

12.1 You must submit the correct eManifest ID and the correct SCID against each Container on the Posting Docket using the fields provided for those purposes.

13 Posting performance

13.1 The performance of your Mailmark Mailing is optimised when:

- a. each Mailing Item is well designed in accordance with this Appendix M;
- b. the address and Postcode on the Mailing Item is consistent with the Postcode and DPS in the Mailmark Barcode on each Mailing Item and in the eManifest;
- c. all address, Postcode and DPS elements match the correct record held in PAF®; and
- d. all Mailing Items have been correctly sorted and presented to the relevant Mail Centre in line with the requirements set out in this User Guide.

14 Mailmark Adjustment framework

14.1 This appendix and the User Guide will assist you in designing your Mailing Items to meet our machine-readable requirements. If we establish to our reasonable satisfaction that you have not complied with one or more of your obligations in Schedule 8, Part 1: Royal Mail Mailmark and the User Guide, and/or the Mailing Items in your Mailmark Mailing require manual or other intervention, we will have the right, without prejudice to our rights set out in the Contract, to take the actions set out in Section 10 of this User Guide.

15 Default postcode option

15.1 The default postcode allows customers to use a default postcode value of XY99 1AA in the Mailmark Barcode and eManifest. This default postcode option should be used where a Postcode or DPS cannot be captured but the Mailing Item otherwise meets the Mailmark specifications. The non-geographic postcode is recognised by Royal Mail systems so that the existing Mailmark Adjustment for incorrect postcode will not be applied. Instead a supplementary service charge will apply for all Mailing Items which exceed the 10% Postcode accuracy tolerance level (see Section 2.1 of this User Guide).

Appendix N: Royal Mail Mailmark® Economy

1 Introduction

1.1 This appendix sets out the specification requirements you must adhere to when posting Mailing Items using the Mailmark Economy Service, in addition to the requirements you must comply with as set out in Schedule 8, Part 2: Royal Mail Mailmark Economy.

2 Qualification

2.1 To qualify as Mailmark Economy Mail, you must ensure that you use Royal Mail Mailmark®, and that Mailing Items have dimensions which meet the specifications for a Letter as set out in this User Guide.

3 Sortation, Service, Format and processing options

3.1 The Mailmark Economy Service can be used with the following sortation, Format, processing option and Access Service options:

Sortation level	Access 70
Format	Letter (including postcards, provided that such postcards meet the requirements set out below)
Processing option	Royal Mail Mailmark
Access Service options	Advertising Mail Partially Addressed Mail Business Mail

3.2 You must ensure to meet the specifications and requirements of Royal Mail Mailmark and the Access Service you are declaring the Letter items as.

4 Postcards

4.1 If sending postcards using the Mailmark Economy Service, you must ensure that you comply with the machineable postcard specification set out in section 6 of our [Mailmark Letters specification](#).

5 Additional Mailmark Barcode and eManifest requirements

5.1 To use the Mailmark Economy Service you will need to change the Mailmark Barcode and eManifest to denote the Economy service as specified in our [Mailmark Economy Service Technical Guide](#).

6 Presentation

6.1 Each bag or tray you use to hand over Mailmark Economy Mail to us under the Contract must contain only Mailmark Economy Mail. Additionally, you must not mix Letters posted using different Access Service options, for example Advertising Mail and Business Mail, in each bag or tray. Yorks which you hand over to us may include a mix of bags and/or trays comprising Mailmark Economy Mail with bags and/or trays which do not comprise Mailmark Economy Mail.

6.2 Mailmark Economy Mail may be presented in Yorks with other UCID Postings or Consolidated Postings, as long as you use Yorks in line with this Contract.

7 Container labels

7.1 Each bag and/or tray you use to hand over Mailmark Economy Mail must be labelled in accordance with normal requirements as specified in Section 5 of this User Guide. We do not require the bag and/or tray labels to indicate that the bag and/or trays contain Mailmark Economy Mail.

7.2 However if you require the labels to indicate the bags and/or trays contain Mailmark Economy Mail for your own operational purposes, you can choose to make such an indication within the Customer Type Indicator box of the label, as long as you continue to meet all other labelling requirements as specified in Section 5 of this User Guide.

8 Product codes

8.1 You must use the Mailmark Economy Service product codes when declaring Letters using the Mailmark Economy Service, as specified in the Royal Mail Service List which lists all Access Services and their corresponding DocketHUB and SAP codes.

8.2 You can access the Service List via DocketHUB in the 'Reports' section under the 'Service Status List' category.

Appendix O: Royal Mail Manual Mailmark®

1 Introduction

1.1 This appendix sets out the specification requirements you must adhere to when posting General Large Letters using the Manual Mailmark Service, in addition to the requirements you must comply with as set out in Schedule 8, Part 3: Royal Mail Manual Mailmark.

2 Qualification

2.1 To qualify as Mailmark Economy Mail, you must ensure that you comply with the requirements specified in Schedule 8, Part 3: Royal Mail Manual Mailmark and this Appendix O.

2.2 Each Manual Mailmark Mail Posting must comply with the specification requirements set out in Paragraphs 6, 9, 10 11 and 12 of Appendix M: Mailmark of this User Guide, in respect of which:

a. the relevant definitions in Schedule 8, Part 1: Royal Mail Mailmark and Appendix M shall apply accordingly, subject to, for the purposes of this Appendix Q only:

- i. references to 'Mailmark Mailing Items' shall be construed as references to 'Manual Mailmark Mailing Items';
- ii. references to 'Letter' and/or 'Large Letter' formats shall be construed as references to 'General Large Letters'; and,

iii. Paragraph 6 of Appendix M of this User Guide shall be deemed amended to read as follows:

"You must ensure each Mailing Item within a Mailmark Mailing:

- a. has a Mailmark Barcode printed on it in addition to any other marks that are required for the Access 70 or 1400 Mailing Item in question;*
- b. has a Mailmark Barcode printed on it in a manner and location and in accordance with the specifications, as set out in the Mailmark Letters and Large Letters specification below."*

2.3 In addition to the requirements set out in this Paragraph 2, any Manual Mailmark Mail posted must comply with the posting performance optimisation requirements set out in Paragraph 13 of Appendix M of this User Guide except for the requirements in respect of DPS accuracy. Failure to meet these performance requirements may result in us taking one or more of the actions set out or referred to in Section 10 of this User Guide.

3 Sortation, Service and Format

3.1 The Manual Mailmark Service can be used with the following sortation and Access Service options:

Sortation level	Access 70 Access 1400
Access Service	General Large Letters
Dimensions	Maximum 353mm x 250mm
Thickness	Maximum 25mm
Weight	Minimum 10g, Maximum 750g

4 Additional Mailmark Barcode requirements

- 4.1 You must apply Mailmark Barcodes to all Manual Mailmark Mail Postings and each such Posting must be uploaded to the eManifest to qualify as Manual Mailmark Mail.
- 4.2 However you will need to change the Mailmark Barcode to denote the Manual Mailmark Service as specified in our [Manual Mailmark Service Technical Guide](#).

5 Presentation

- 5.1 The choice of Container you can use to post Manual Mailmark Mail depends on the thickness of the items:

	Bags	Trays	ALPS
General Large Letters less than 10mm thickness	Yes	Yes	No
General Large Letters more than 10mm thickness	Yes	No	Yes

- 5.2 Each Container you use to hand over Manual Mailmark Mail to us under the Contract must contain only Manual Mailmark Mail.

6 Container labels

- 6.1 Each bag and/or tray you use to hand over Mailmark Economy Mail must be labelled in accordance with normal requirements as specified in Section 5 of this User Guide.

7 Product codes

- 7.1 You must use the Manual Mailmark Service product codes when posting Manual Mailmark Mail, as specified in the Royal Mail Service List which lists all Access Services and their corresponding DocketHUB and SAP codes.
- 7.2 You can access the Service List via DocketHUB in the 'Reports' section under the 'Service Status List' category.

8 Default postcode option

- 8.1 The default postcode allows customers to use a default postcode value of XY99 1AA in the Mailmark Barcode and eManifest. This default postcode option should be used where a Postcode or DPS cannot be captured but the Mailing Item otherwise meets the Manual Mailmark specifications. The non-geographic postcode is recognised by Royal Mail systems so that the existing Mailmark Adjustment for incorrect postcode will not be applied. Instead a supplementary service charge will apply for all Mailing Items which exceed the 10% Postcode accuracy tolerance level (see Section 2.1 of this User Guide).

Appendix P: Poll card services

1 Introduction

1.1 Poll cards are uniquely used by local councils to notify constituents of elections. You may post poll cards as Manual Items and pay the applicable Manual Item price. Alternatively you may choose to post poll cards using one of the following services which will enable you to benefit from additional price savings:

- a. **Royal Mail Mailmark®:** we detail an enhanced Mailmark specification for sending poll cards in Paragraph 3 of this appendix;
- b. **Royal Mail Poll Sort:** this is a manual service for posting services where we have a delivery aim of 3 Working Days. See Paragraph 4 of this appendix for specification details.

1.2 You can find prices for both these Services on our Website.

2 Poll card dimensions

2.1 We require poll cards to meet the following specified dimensions:

Format	Container	Service	Size	Weight	Thickness	Shape
Letter	Tray only	Mailmark	210mm x 150mm (plus a manufacturing tolerance of plus or minus 2mm)	Max: 20g	Min: 0.18mm	Rectangle Each corner 90° Landscape.
		Poll Sort	Max: 240mm x 165mm	Max: 20g	Min: 0.25mm	Rectangle Each corner 90° Landscape.

3 Using Royal Mail Mailmark® to post poll cards

3.1 Unless otherwise specified in this Paragraph 3, the requirements set out in Appendix M: Mailmark apply to poll cards posted using Mailmark services. The requirements set out in this Paragraph 3 are mandatory for poll cards posted using Mailmark.

3.2 Please note:

- a. these requirements apply to the finished mailpiece as presented to Royal Mail and take precedence over the standard Mailmark specifications;
- b. where not otherwise specified, the physical, artwork and presentation requirements are aligned to the standard Mailmark Letter mailing requirements set out in Appendix M: Mailmark;
- c. this section also outlines the required accreditation process.

3.3 Each specification requirement has been assessed and is categorised as either 'Mandatory' (M), or 'Recommended High Risk' (H) or 'Recommended Low Risk (L)':

- a. Poll cards that fail to meet the 'Mandatory' requirements are regarded as unmachineable and are very likely to have Adjustments applied.

- b. Poll cards which fail to meet the requirements that are identified as 'Recommended - High Risk' have a higher likelihood of performing poorly through our processing machines. Poll cards that fail to meet these requirements are more likely to have Adjustments applied and may become damaged in our processing machines.
- c. Poll cards which fail to meet the requirements that are identified as 'Recommended - Low Risk', may perform poorly through our processing machines. However, the risk is lower than that posed by failure to meet the 'Recommended High Risk' specifications and there is less chance of the Poll cards being damaged or Adjustments being applied.

3.4 We have provided guidance footnotes that explain the risks associated with not meeting the 'Recommended' High and Low risk requirements.

4 Mailmark Accreditation (QA Process)

4.1 Customers wishing to use Mailmark to post poll cards must be successfully accredited. These options will then be added to their posting account. To receive accreditation, customers must have passed the required elements of the Royal Mail QA process, designed to monitor performance on:

- a. Physical mailpiece design processing test;
- b. Machine-readability;
- c. Address management;
- d. DPS allocation and accuracy.

4.2 Royal Mail have developed the QA process to check the above elements against benchmark standards. Meeting these allows customers to access discounts for machine-readability and the ability to benefit from the discounts available.

5 Mailmark Poll Card Physical Design

5.1 Physical requirements for poll cards are detailed below and illustrated in Paragraph 6 below. The poll card must be produced from a sheet of paper that is cut, folded twice and adhered on all sides. This shall provide a rectangular finished mailpiece in landscape orientation that has 2/3 Ply thickness (the 3 Ply being at the bottom of the mailpiece).

Category		Specification Requirement	M/R
Size & Shape	Shape	Rectangular or square with straight sides and 90° corners.	M
	Orientation	Landscape or portrait.	M
	Finished Size (H x L)	210mm x 150mm (plus a manufacturing tolerance of plus or minus 2mm).	M
	Paper Sheet Thickness	Greater than or equal to 0.18mm	M
Poll Card Adhesive	Flexibility	Each Letter must be capable of being transported around a pulley with a radius of 140mm with a max force of 26N.	M
	Material	Poll cards must be made from matt or silk finish paper only (matt preferred).	M
		<ul style="list-style-type: none"> • A permanent and continuous adhesive seal of 15mm width is required on 3 sides of the poll card as illustrated in Figure 40 and Figure 42. • The adhesive must go to the edge of the mail piece. 	M

Sealing	<ul style="list-style-type: none"> The adhesive must be no more than 80 microns thick. 	M
	<ul style="list-style-type: none"> The glue must not seep onto the outside of the mail piece and must not produce protruding mounds on the mail piece. 	M
	<ul style="list-style-type: none"> The glue must not be brittle or designed to be easily broken. 	M
	<ul style="list-style-type: none"> The peak peel adhesion strength of the glue must be at least 0.4N. 	M
	<ul style="list-style-type: none"> The cure time for the glue must be sufficient to ensure that it has fully cured prior to posting ¹. 	M
Paper Weight	Minimum - 70gsm	M
Opacity	The paper used should be at least 85 % opaque (BS ISO 2471 - Paper and board. Determination of opacity).	H ²

Category		Specification Requirement	M/R
Poll Card Design & Construct. Cont.	Absorbency	The paper used should have an absorbency of 15–35 gsm of water in 1 minute (BS EN 20535 - Paper and board. Determination of water absorptiveness.).	H ³
	Porosity	The paper used should have a porosity value of less than 700ml per minute (BS 6538-2 - Air permeance of paper and board.)	L ⁴
	Construction	One of the following 2 design options must be used:	M
		<ol style="list-style-type: none"> The 3-ply paper must be cut finished so all three layers form a single bottom (reference) edge as illustrated in Figure 40. i.e. the edge consists of 3 layers of paper and 2 layers of adhesive as illustrated in Figure 41. The finished cut edge must look as if it is a single edge; OR The paper must be folded such that the first fold creates an internal flap that is 66mm deep (a manufacturing tolerance of plus or minus 2mm is permitted). The second fold must form another flap that covers the internal flap and ends 1mm short of the bottom (reference) edge. This is illustrated in Figure 41 and Figure 43. 	
	Presentation	<ul style="list-style-type: none"> The poll card must be flat and not curled when presented to us. 	M
<ul style="list-style-type: none"> Poll cards may be placed in trays with the indicia uppermost and with the PPI facing the tray label (so that the heavier base is on the bottom). 		H ⁵	

The helps to ensure that the cards do not stick together.

² This facilitates Mailmark, address, and Indicia reading.

- ³ This facilitates the application of codes and artwork to the Letter (i.e. the ink soaks in and does not rub off).
- ⁴ This facilitates the singulation of the mail at machine infeed (i.e. fewer double fed Letters and missorts).
- ⁵ This reduced the potential for the cards to curl.

6 Mailmark Poll Card - Physical Design Figures

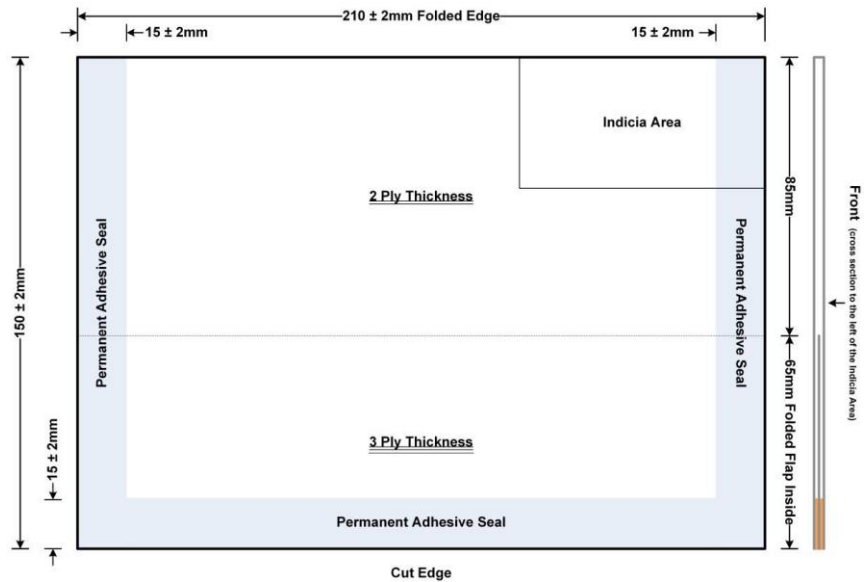

Figure 40: Physical Design - Option 1⁶



Figure 41: Physical Design - Cut Edge

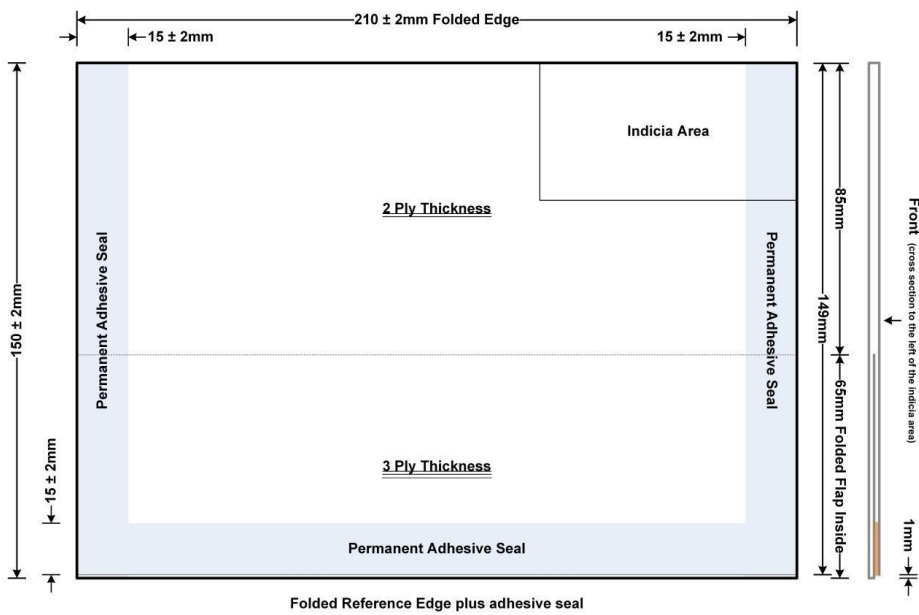

Figure 42: Physical Design - Option 2⁶

⁶The dotted line marks the point where the card thickness varies.

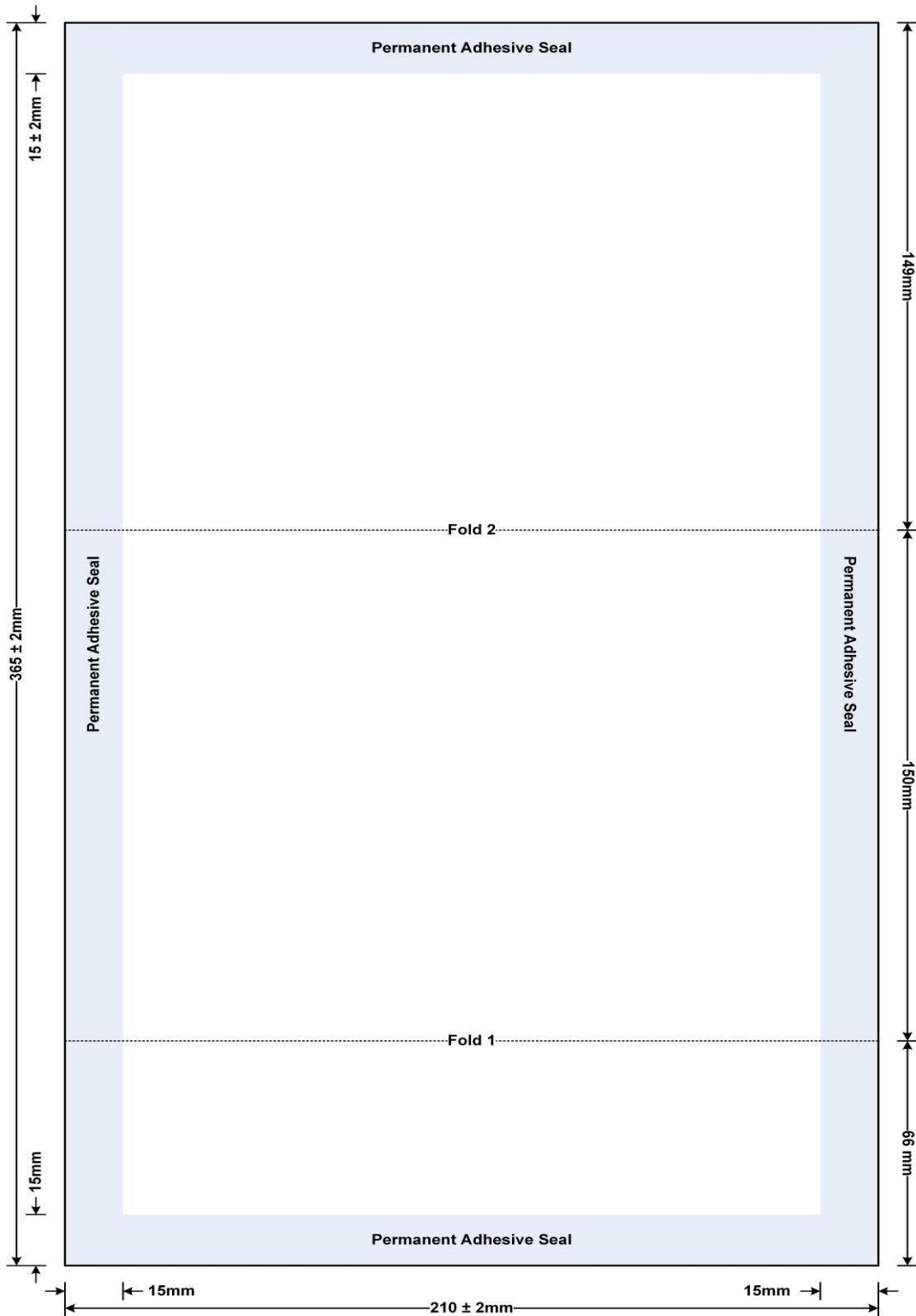

Figure 43: Physical Construction

7 Mailmark Poll Card General Layout – Indicum

7.1 Only standard approved indicia designs may be used. Stamp-Like Indicia and Digital Indicia must not be used on poll cards. Indicia requirements are the same as those for Letters (see Section 3 of the User Guide).

8 Mailmark Poll Card General Layout – Artwork

8.1 Two design variants are provided for poll cards posted using Mailmark. They enable some flexibility in the location of the voting information. The Indicia and Delivery Address block must be printed on the front of the poll card together with either the polling station information or return address.

8.2 The red text in the dimensional front and back layout drawings indicates the variable text fields. The black areas are fixed text.

8.3 Front Artwork:

- a. The design requirements for the front of the Mailmark poll card are summarised below and illustrated in Figure 44.
- b. In this section, mandatory requirements ensure that sufficient address content is provided to enable Royal Mail to optimise the effective sortation of the mail, whilst recommended requirements provide some design flexibility where this is not detrimental to processing performance.

Category		Specification Requirement	M/R
Poll Card Front Artwork	General	Only the poll card information boxes, Indicia, Mailmark and Delivery Address block shall be printed on the front of the mailer as illustrated in Figure 44.	M
	Polling Station / Return Address	<ul style="list-style-type: none"> • The top left corner provides a field for either: <ul style="list-style-type: none"> o Option 1 - the polling station address prefixed by the words 'Your polling station will be'; OR o Option 2 - the return address prefixed by the words 'Return Address'. 	M
		<ul style="list-style-type: none"> • Standard Mailmark requirements regarding return address punctuation, text formatting, printing and background, and clear zones apply to the polling station / return address. 	M
		<ul style="list-style-type: none"> • The polling station /return address must be printed in Letter Gothic 12pt font. 	M
	Indicia	The Indicia together with its required clear zone must be located in the 75mm (103mm where PPI designs 3 or 4 are used) x 40mm plus or minus 2mm Indicia area in the top right corner of the mailer.	M
	Poll Card Box	A variable 'Poll Card Box' defines the election type and the purpose of the card in up to 3 lines of text. The content of the box may be modified subject to the requirements below:	
		<ul style="list-style-type: none"> • The text must be printed centre justified and must not be shaped like a Delivery Address block. • This should be 103mm long, 30mm high, be inset by 2mm from the left edge and must not extend into the area 40mm from the top edge. 	M H

	<ul style="list-style-type: none"> It is recommended that the text is printed in white on a black background and using following fonts: <ul style="list-style-type: none"> Line 1 (variable text) – Arial Black 14pt Title Case Line 2 (Poll Card) – Arial Black 22pt Capitals Line 3 (Voting Details) – Arial Black 14pt Normal case 	H
Polling Day / Information Box	A variable 'Candidate Information or Polling Day Information Box' defines the election type and the purpose of the card in 3 or 4 lines of text. The content of the box may be modified subject to the requirements below.	
	<ul style="list-style-type: none"> The box must not extend into the indicia area. 	M
	<ul style="list-style-type: none"> The text must be printed centre justified and must not be shaped like a Delivery Address block. 	M
	<ul style="list-style-type: none"> The box should be 103mm long, 30mm high, and be inset by 2mm from the right edge. 	H
	<p>The content options are as follows:</p> <ul style="list-style-type: none"> Option 1 - Polling Day OR Option 2 - Candidate reference information 	H
	<ul style="list-style-type: none"> It is recommended that the text is printed in white on a black background and using Arial Black 14pt Normal case font. 	H
Delivery Address Block	<ul style="list-style-type: none"> The Delivery Address block must be printed beneath the poll day and Information boxes in an area 57mm high and 95mm long and be inset by 15mm from the left and right edges, and 18mm from the bottom edge. 	M
	<ul style="list-style-type: none"> The standard Tag Codemark clear zone must be observed. 	M
	<ul style="list-style-type: none"> Standard Mailmark address content and formatting requirements apply. 	M
	<ul style="list-style-type: none"> Voter registration references may be included as Mailer Defined Information above the Delivery Address. 	H
	<ul style="list-style-type: none"> The use of a Non-Proportionally Spaced is highly recommended. 	H
	<ul style="list-style-type: none"> The use of a 12pt Font is highly recommended. 	H

c. The layout of the front of the poll card is illustrated below:

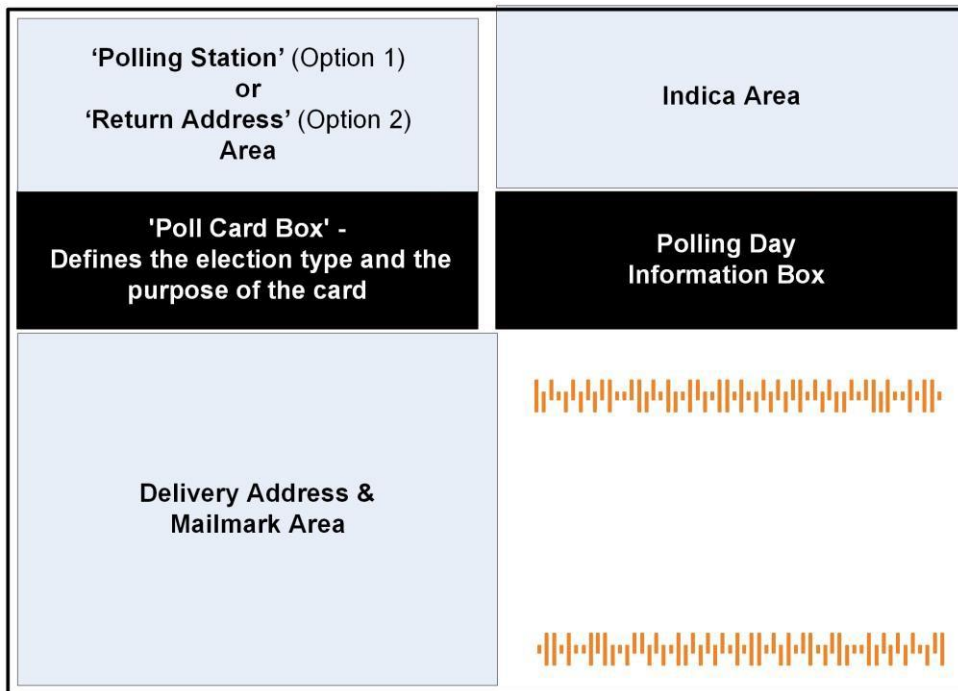

Figure 44: Poll Card Layout – Front

8.4 Back Artwork:

- a. The back of the poll card provides the required voting information with variable content being included for date, time, address, and content information that is not printed on the front of the mailpiece. The back designs for the 2 options are illustrated in Figures 48 and 52.

Category		Specification Requirement	M/R
Poll Card Back Artwork	Polling Station / Return Address	<ul style="list-style-type: none"> The top left corner provides a field for either: <ul style="list-style-type: none"> Option 1 - the polling station address prefixed by the words 'Your Polling station will be' OR Option 2 - the return address prefixed by the words 'Return Address'. 	M
		<ul style="list-style-type: none"> Standard Mailmark requirements regarding return address punctuation, text formatting, printing and background, and clear zones apply to the polling station / return address. 	M
		<ul style="list-style-type: none"> The polling station / return address must be printed in Letter Gothic 12pt font. 	M
	Other Content	<ul style="list-style-type: none"> No other text block must not be shaped like an Address Block. It is recommended that Arial font is used for the other content on the back of the poll card. 	H L

9 Mailmark Poll Card – Artwork Figures



Figure 45: Option 1 Artwork – Wholesale English Front

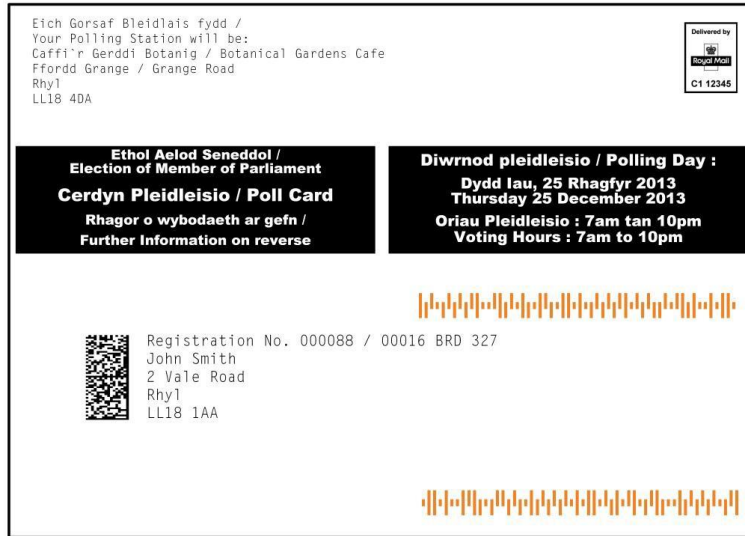

Figure 46: Option 1 Artwork – Wholesale Welsh Front

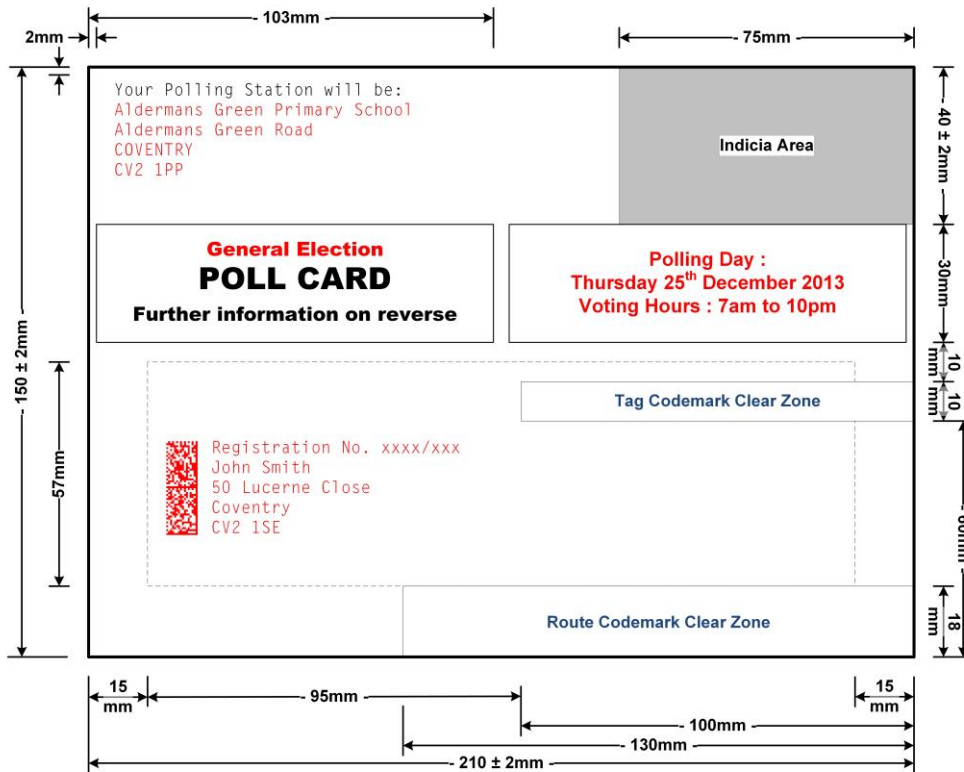

Figure 47: Option 1 Dimensions - Wholesale Front⁸

⁸ The red text in the drawings indicates the variable text fields. The black areas are fixed text.

<p>Return Address Local Returning Officer Election Services Coventry City Council Council House Earl Street Coventry CV1 5RR</p>	<p>If you will be away or cannot go to the polling station on Thursday 25th December 2013 you can:</p> <ul style="list-style-type: none"> Apply to vote by post. The deadline for completed applications is 5pm on Wednesday 10th December 2013. We will send out postal votes about 7-10 days before the election. If you are given a postal vote, you will not be able to vote in person at this election. <p>OR</p> <ul style="list-style-type: none"> Apply to vote by proxy (this means someone else can vote on your behalf) the deadline for completed applications is 5pm on Wednesday 17th December 2013. If you appoint a proxy, you can vote if you wish, but only if your proxy has not already voted on your behalf, and has not got a postal vote for you.
<p>How to vote:</p> <ol style="list-style-type: none"> At a polling station, go to the desk and tell the staff your name and address. They will give you your ballot papers. Go to one of the voting booths. Read the instructions in the booth and mark your ballot papers. Fold the ballot paper(s) and put them in the box(es). <p>If you need help, just ask the staff.</p>	<p>If you have a medical emergency after 5pm on Wednesday 10th December 2013. If you become ill and cannot go to the polling station, you can apply to vote by emergency proxy. This means that someone else can vote on your behalf. The deadline for completed applications is 5pm on Thursday 25th December 2013. To find out how to apply, phone the helpline straight away.</p>
<p>If you need help contact us</p>	<p>For information on candidates standing in your area go to www.choosemymp.org.uk or ☎ 0800 123 4567</p>
<p>Helpline number: XXXXX XXXXXX Email: xxxxxxxx@xxxxxxx.gov.uk www.xxxxxxxx.gov.uk</p>	

Figure 48: Option 1 Artwork – Back⁸

<p>Return Address Local Returning Officer Election Services Council House Earl Street Coventry CV1 5RR</p>	<p>Delivered by C1 12345</p>
<p>General Election POLL CARD Further information on reverse</p>	<p>For information on candidates standing in your area go to www.choosemymp.org.uk or ☎ 0800 123 4567</p>
<p> Registration No. xxxx/xxx John Smith 50 Lucerne Close Coventry CV2 1SE</p>	<p></p>

Figure 49: Option 2 Artwork – Wholesale English Front

<p>Eich Gorsaf Bleidlais fydd / Your Polling Station will be: Caffi'r Gerddi Botanig / Botanical Gardens Cafe Ffordd Grange / Grange Road Rhyl LL18 4DA</p>	<p>Delivered by C1 12345</p>
<p>Ethol Aelod Seneddol / Election of Member of Parliament Cerdyn Pleidleisio / Poll Card Rhagor o wybodaeth ar gefn / Further information on reverse</p>	<p>Diwrnod pleidleisio / Polling Day : Dydd Iau, 25 Rhagfyr 2013 Thursday 25 December 2013 Oriau Pleidleisio : 7am tan 10pm Voting Hours : 7am to 10pm</p>
<p> Registration No. 000088 / 00016 BRD 327 John Smith 2 Vale Road Rhyl LL18 1AA</p>	<p></p>

Figure 50: Option 2 Artwork – Wholesale Welsh Front

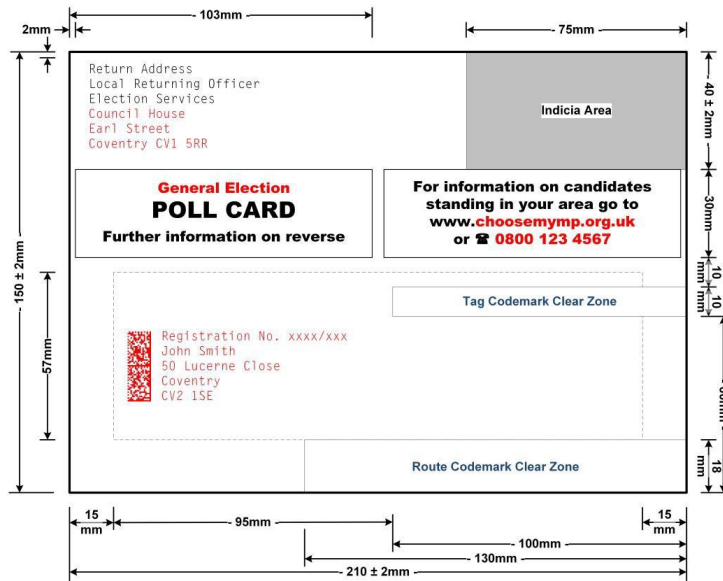

Figure 51: Option 2 Dimensions - Wholesale Front

<p>Voting Information</p> <p>Polling Day: Thursday 25th December 2013</p> <p>Polling Hours: 7am to 10pm</p> <p>Your Polling Station will be: Aldermans Green Primary School Aldermans Green Road COVENTRY CV2 1PP</p>	<p>If you will be away or cannot go to the polling station on Thursday 25th December 2013 you can:</p> <ul style="list-style-type: none"> Apply to vote by post. The deadline for completed applications is 5pm on Wednesday 10th December 2013. We will send out postal votes about 7-10 days before the election. If you are given a postal vote, you will not be able to vote in person at this election. <p>OR</p> <ul style="list-style-type: none"> Apply to vote by proxy (this means someone else can vote on your behalf) the deadline for completed applications is 5pm on Wednesday 17th December 2013. If you appoint a proxy, you can vote if you wish, but only if your proxy has not already voted on your behalf, and has not got a postal vote for you.
<p>How to vote:</p> <ol style="list-style-type: none"> At a polling station, go to the desk and tell the staff your name and address. They will give you your ballot papers. Go to one of the voting booths. Read the instructions in the booth and mark your ballot papers. Fold the ballot paper(s) and put them in the box(es). <p>If you need help, just ask the staff.</p>	<p>If you have a medical emergency after 5pm on Wednesday 10th December 2013.</p> <p>If you become ill and cannot go to the polling station, you can apply to vote by emergency proxy. This means that someone else can vote on your behalf. The deadline for completed applications is 5pm on Thursday 25th December 2013.</p> <p>To find out how to apply, phone the helpline straight away.</p>
<p>If you need help contact us</p>	<p>Helpline number: XXXXX XXXXXX Email: xxxxxxxx@xxxxxxxx.gov.uk www.xxxxxxxxxx.gov.uk</p>

Figure 52: Option 2 Artwork - Back

10 Mailmark Poll Card – Mailmark Barcode requirements

10.1 Mailmark 2D Code formats or 4-State Barcode L are acceptable for poll card postings. The Mailmark Barcode requirements for poll cards are the same as those for Letters (see Appendix M: Mailmark).

10.2 The Mailmark Barcode content for poll cards is illustrated below, with the field length being included in (brackets):

2D Barcode Content:

UPU Country Id. (4)	Info Type Id. (1)	Version Id. (1)	Class (1)	Supply Chain Id. (7)	Item ID (8)	Destination Postcode (9)	RTS Service Type (1)	RTS Postcode (7)	Reserved (6)
JGB (space after the 'B')	P – Poll Cards	1	1 or 2	nnnnnnn	nnnnnnn n	Standard Postcode format (inc. delivery point)	n	Std Postcode format (No. delivery point)	(6 Spaces)

4-State Barcode L Content:

Format (1)	Version (1)	Class (1)	Supply Chain Id. (6)	Item ID (8)	Destination PC (9)
1	1	1 or 2	nnnnnn	nnnnnnnn	Std Postcode format (inc. delivery point)

11 Mailmark Poll Card - eManifest requirements

11.1 When posting Mailmark poll card items, the eManifest must include Information Type ID value 'P' (Poll Cards) rather than the typical value '0' (Bulk Mail).

12 Mailmark Poll Cards - Postal voting mailer artwork

12.1 This paragraph illustrates the artwork requirements for postal voting cards. Physical, Indicia, formatting, and Mailmark requirements for postal voting cards are the same as those for other poll cards as set out above.



Figure 53 – Postal Voting Artwork – Wholesale English Front

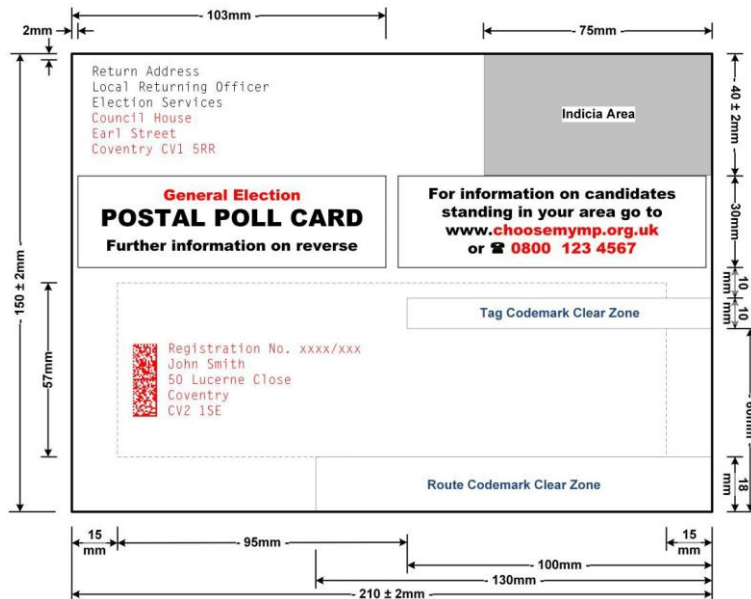

Figure 54 – Postal Voting Dimensions - Wholesale English Front

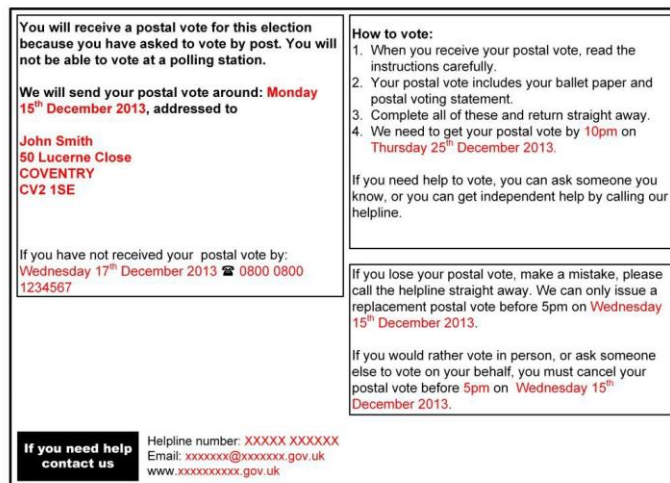

Figure 55 – Postal Voting Artwork – Back

13 Mailmark Poll Cards – Welsh language

13.1 Bi-lingual English / Welsh content may be included within the Poll Card design in line with the following additional requirements:

Category		Specification Requirement	M/R
Welsh	Polling Station / Return Address	The Polling Station / return address may be printed in English or Welsh (where provided in PAF). The inclusion of return addresses printed in both English and Welsh is not permitted.	M
	Delivery Address Block	It may be wholly printed in English, or wholly in Welsh where a Welsh address is provided in PAF. The inclusion of addresses printed in a combination of English and Welsh is not permitted.	M

14 Royal Mail Poll Sort

14.1 Royal Mail Poll Sort is a manual service for the posting of poll cards only ("**Poll Sort**"). We aim to deliver within 3 working days. Unless otherwise stated in Paragraphs 14 to 18 of this appendix, the standard presentation requirements for Letters apply, as specified in the Contract and this User Guide.

14.2 The requirements set out in this Paragraph 14 are mandatory for poll cards posted under Poll Sort. If they contradict any of the specification requirements as set out elsewhere in the Contract and this User Guide, the poll card requirements, for non-machineable Mailmark poll cards, set out in this Paragraph 14 take precedence.

15 Sortation

15.1 Under poll sort, you must sort poll cards to approximately 60,000 selections using the specified Election Sort Selection File as contained within the Access Selection Files. You must use the current version of the Access Selection Files.

16 Forecasting

16.1 When presenting Poll Sort you must follow the KNP process as defined in Appendix B: Key National Posting (KNP).

17 Presentation

17.1 The following presentational requirements are mandatory for poll cards sent using the Poll Sort service:

Category		Specification Requirement	M/R
Size & Shape	Shape	Rectangular or square with straight sides and 90o corners.	M
	Orientation	Landscape or portrait.	M
	Finished Size (H x L)	240mm x 165mm.	M
	Paper Sheet Thickness	Min: 0.25mm no thicker than 5mm.	M
	Weight	Max 20g.	M
Physical presentation	Indicia	<ul style="list-style-type: none"> Each item must clearly show the Indicia and the wording 'Delivered by Royal Mail'. This must be printed in the top right hand corner of the front face of the items in either 12 or 14 point font size. 	M
	Addressing	a. Items must be 100% fully addressed and post coded.	M
	Bundling	b. Items in a bundle must be facing same way and facing up.	M
		c. Items for a single delivery walk must be bundled separately, labelled according to walk name, and must not contain anything other than poll cards.	
	d. Bundles must be banded using elastic or paper bands. e. Maximum 100 items in each bundle. f. Bundles with less than 10 items must be single banded.		

Container	<ul style="list-style-type: none"> • Poll cards must be handed over to RM in Trays only • Each Tray may contain multiple walks. • Trays must be clearly labelled detailing the Delivery Office name. 	M
------------------	---	----------

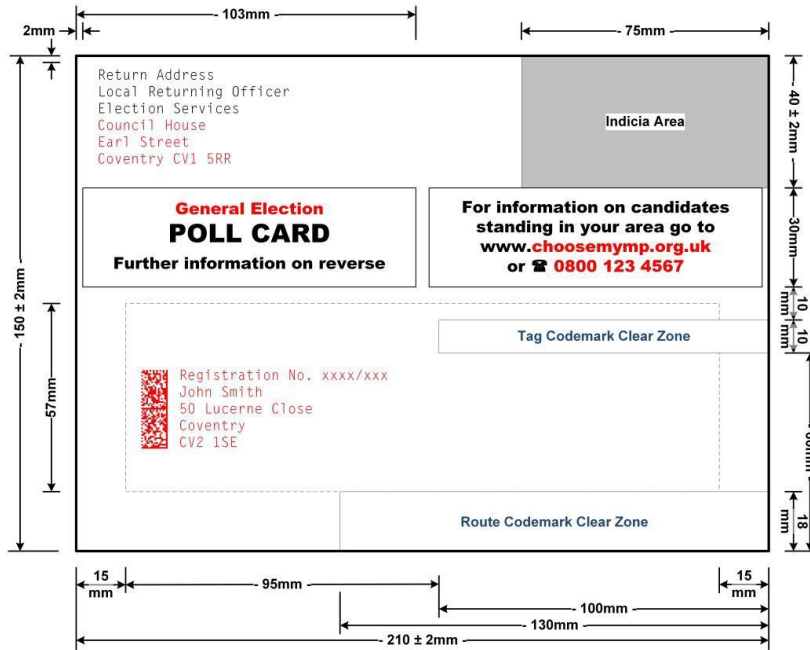

18 Labelling

18.1 Standard Manual Item **White** labelling requirements apply with the addition of the following:

- use a bundle label that identifies an individual walk;
- Tray labels and York cards must clearly be identified as poll sort. Examples of labels are shown below in Figures 56 to 59.

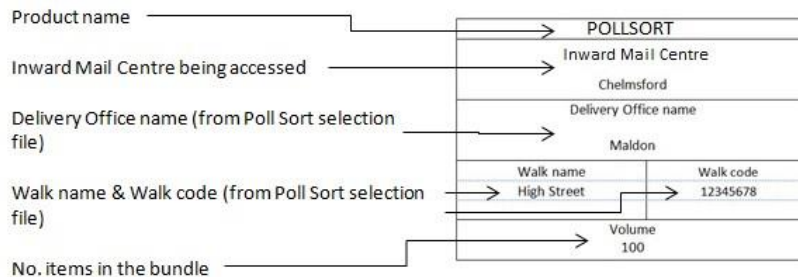

Figure 56: Poll Sort bundle label

Figure 57: Poll Sort tray label

Figure 58: Poll Sort York card (standard)

1. York ID → York ID

2. Carrier name → Carrier Name

3. IMC - name of the IMC being accessed → Mail Centre Name

4. Letters → Mail Format

5. List all your customers contained within the York, by customer name, Contract type and number of Containers

- NAT - National
- ZON - Zonal
- PSN - Poll Sort National
- PSZ - Poll Sort Zonal

6. Date and numbers - you must show the actual date of handover to an individual IMC and the accurate number of Containers contained within the York

Customer	Contract Type	No of	Customer	Contract Type	No of
AN other	NAT	X	AN other	PSN	X
AN other	NAT	X	AN other	PSN	X
AN other	NAT	X	AN other	PSN	X
AN other	ZON	X	AN other	PSZ	X
AN other	ZON	X	AN other	PSZ	X
AN other	ZON	X	AN other	PSZ	X

Date of Handover:

Total No. of trays

Figure 59: Segregation by Format Poll Sort York card

Appendix Q: eManifest Billing

1 Introduction

- 1.1 This appendix sets out the eManifest Billing Specification you must adhere to when using eManifest Billing, in addition to the requirements you must comply with as set out in Schedule 8, Part 4: eManifest Billing of the Contract.
- 1.2 Schedule 8, Part 4: eManifest Billing sets out the eligibility requirements if you want to use eManifest Billing.

2 System and procedural changes

- 2.1 If you are using eManifest Billing, instead of uploading a Posting Docket and Exceptions to DocketHUB, you will need to provide the handover documentation set out in Paragraph 3 below. Therefore you need to make the necessary changes to your software to enable the upload of each of the Vehicle Manifest and eManifest with the information we require.

3 Documentation

- 3.1 You are no longer required to supply a Posting Docket in respect of each Posting via DocketHUB. Instead you must:

- a. upload a Vehicle Manifest to DocketHUB by 08:00 on the day of handover of your Mailing Items; and
- b. ensure your driver hands over two hard copies of the Summary Vehicle Manifest to us upon arrival at the Inward Mail Centre in accordance with Paragraph 3.3 below.

3.2 Submitting an eManifest:

- a. You must continue to upload an eManifest to the EHMS system in accordance Appendix M.
- b. You must include container IDs in spare field 10 and ensure that the weight field is accurately populated in the eManifest.

3.3 Providing Vehicle Declarations and Vehicle Manifests:

- a. By 08:00 on each Working day, you shall accurately make a Vehicle Declaration. If you fail to provide, or provide us with an inaccurate Vehicle Declaration, we may not be able to accept your vehicle(s). If it is operationally practical for us to do so, we shall accept the vehicle(s) but we reserve the right to charge you an administrative charge.
- b. For each Handover Day, you must give us a Vehicle Manifest by 08:00.
- c. Each vehicle must bear a unique vehicle identifier that correlates to the Vehicle Manifest specific to that vehicle and which must be visible and legible to us on arrival at the Inward Mail Centre. Any such vehicle identification methodology that does not use vehicle registration number plates must be agreed in writing by us prior to use.
- d. If you do not supply a Vehicle Manifest in line with this Appendix, you must inform DSACC immediately. We shall refuse access to any vehicle that arrives at an Inward Mail Centre without having notified us in advance of its consignment by submitting a Vehicle Manifest.
- e. If you have uploaded a Vehicle Manifest but the vehicle fails to arrive during the Access Slot, you must inform DSACC immediately. DSACC shall decide whether the vehicle will be cancelled or may have later access to the Inward Mail Centre. If the vehicle is cancelled, you must confirm to us the identity of the vehicle to be cancelled so that the correct Vehicle Manifest is cancelled.

- f. When a vehicle arrives at an Inward Mail Centre, your driver must carry two copies of a Summary Vehicle Manifest. The Summary Vehicle Manifest shall be used in place of the "Summary Manifest" referred to in Section 6.2(b) of the User Guide and the waybill as referred to in Section 6.5(a) of the User Guide. Two copies of the Summary Vehicle Manifest will be signed, timed and dated by one of our employees after the vehicle is unloaded. One copy will be retained by your driver as a delivery note, and the other by the Inward Mail Centre. For clarity, the handover of Mailing Items and the signing of the Summary Vehicle Manifest shall not constitute our acceptance of the Mailing Items.
- g. After the Mailing Items have been unloaded from a vehicle, if we identify that the number of Yorks is not consistent with the number stated on the Vehicle Manifest, or that the Yorks are not labelled in line with the User Guide, we shall not process the Mailing Items until you have remedied the discrepancy. If you cannot do this, we may refuse the Mailing Items of that vehicle and you shall reload the Mailing Items onto your vehicle and remove them from the relevant Inward Mail Centre. We may require you to pay an administrative charge in these circumstances.
- h. Our acceptance of a Posting only occurs after we carry out Revenue Protection checks and any issues have been resolved with you to our satisfaction.

3.4 No requirement for an Exceptions report

- a. You will no longer be required to upload an Exceptions report.
- b. Once you have uploaded an eManifest, you must hand over your Mailing Items associated with that eManifest within 5 days of it being uploaded. If, after uploading the eManifest, you identify containers which you are not going to hand over within such 5 day period, you must inform DSACC.

4 Invoice generation

- 4.1 We will generate an invoice directly from the eManifest which you upload. The invoice will reflect the outcome of any Revenue Protection we have completed on the Mailing Items.
- 4.2 We will continue to provide invoices to you on a weekly basis, but we will also provide you with a daily auto billing report. This report will show you the Mailing Items that we will invoice in accordance with Paragraph 4(a) above.

5 Client Report

- 5.1 We will continue to issue to you a daily Client Report. However the Client Report shall contain only the same data as the eManifest.

Appendix R: Machinable Items (Discontinued)

The Machinable Items option has been discontinued effective from 1 April 2024.

Appendix S: Trunking Services

1 Introduction

1.1 This appendix sets out the specification requirements you must adhere to when using a Trunking Service and participating in a Trunking Scheme, in addition to the requirements you must comply with as set out in Schedule 4, Part 4: Trunking Services of the Contract.

2 Trunking Scheme Particulars

2.1 We shall publish potential and live Trunking Schemes on our Website in the following format:

Trunking Scheme name: [Insert Details]

Trunking Scheme Start Date:	[Insert Date] (or as otherwise agreed by us and the Carriers)
Trunking Scheme Period	12 months after the Trunking Scheme Start Date
Handover Inward Mail Centre:	[Insert IMC]
Handover Time:	[Insert Time]
Destination Postcode Areas:	[Insert Postcode Areas]
Destination Inward Mail Centre:	[Insert IMC]
Access Window:	[Insert Time] to [Insert Time] on any Working Day
Carrier Combined York Allocation	[Insert Yorks]
Your York Allocation	[Insert Yorks]
Trunking Fee:	[Insert Fee]

3 Presentation

3.1 For each Trunking Scheme, for the duration of the specified Trunking Scheme Period, provisions of the Contract that require you to hand over Mailing Items to the Inward Mail Centre that bears Postcodes served by that particular Inward Mail Centre shall for the purposes of Mailing Items for the Destination Postcode Areas be read as references to the Handover Inward Mail Centre. For the avoidance of doubt, where you have elected to participate in a Trunking Scheme, you may only use the Handover Inward Mail Centre to hand over Mailing Items for the Destination Postcode Areas and you shall not be permitted to hand over such Mailing Items at the original Inward Mail Centre.

3.2 Mailing Items presented at the Handover Inward Mail Centre as part of a Trunking Scheme must be unloaded from your vehicle(s) and handed over to us at Handover Inward Mail Centre in Yorks by the Handover Time on each Working Day.

3.3 If you present any Mailing Items after the Handover Time, we may (at our sole discretion) either:

- a. reject all those Mailing Items presented after the Handover Time; or
- b. accept either some or all of those Mailing Items presented after the Handover Time. In these circumstances, we shall use our reasonable endeavours to deliver such Mailing Items in accordance with the Contract and Schedule 4, Part 4: Trunking Services, but we shall not be in breach of the Contract or Schedule 4, Part 4: Trunking Services if we fail to meet any service standard in relation to such Mailing Items.

3.4 Each York must only contain Mailing Items for the Destination Postcode Areas. We will carry out any checks of the Mailing Items under Clause 3.3(a) of the Contract at the Handover Inward Mail Centre. If we find missorted Mailing Items during the processing of the Mailing Items at the Handover Inward Mail Centre, we will process the missorted Mailing Items and correct the Postage by amending the Posting Docket to reflect that the relevant Mailing Items will be charged at the prevailing 'Missorts Processed' rate, or in the case of Mailmark items, at the 'Missorts' charge, as published on our Website. There will be no option for you to collect the missorted Mailing Items.

3.5 Each York you use to hand over Mailing Items for the Destination Postcode Areas must display a York card which clearly and visibly shows the Destination Inward Mail Centre as the destination office in the format as specified in Section 6.5(b) of this User Guide.

3.6 You must segregate Yorks containing Mailing Items for the Destination Postcode Areas from Yorks containing Mailing Items for other Postcode Areas. You must load all Yorks containing Mailing Items for the Destination Postcode Areas onto one vehicle and at the rear of that vehicle. This will facilitate an efficient process for cross-docking the Yorks to our vehicles Scheduled for transportation to the Destination Inward Mail Centre. In the event that you have not complied with this Paragraph 3.5 we may treat the relevant Posting as non-compliant and refuse the handover of the same.

4 Documentation

4.1 You must inform us by 06:30 each Working Day of the number of Yorks that you will present to us that Working Day.

4.2 You must present your Manifest and waybill documentation for Mailing Items for the Destination Postcode Areas upon arrival at the Handover Inward Mail Centre.

5 Handover

5.1 The Access Window you will be required to handover Mailing Items under a Trunking Scheme will be as specified in the relevant Trunking Scheme Particulars.

5.2 If you have not already booked an Access Slot during the Access Window stated in the Trunking Scheme Particulars, you must book an Access Slot at least two weeks before the date of handover of Mailing Items for the Destination Postcode Areas.

5.3 For the avoidance of doubt, Your York Allocation applies to each individual Posting and failure to utilise your maximum York Allocation on any given Posting does not require us to carry Yorks in excess of Your York Allocation on any other Posting.

5.4 For the purposes of meeting handover obligations stated elsewhere in this Contract, Mailing Items for the Destination Postcode Areas which are presented to a Handover Inward Mail Centre as part of a Trunking Scheme are considered to have been handed over at the Destination Inward Mail Centre and therefore:

- a. will contribute towards the minimum posting requirements for the Destination Inward Mail Centre in Clause 3.3(a) of the Contract; and
- b. at the Handover Inward Mail Centre, those Mailing Items will not contribute towards the requirement under Section 8.1(c) of this User Guide for you to ensure that, over each Contract Year, on average a minimum of 50% of your annual volume of Mailing Items due for hand over at Multiple Slot Mail Centres shall be handed over in your Early Access Slots.

5.5 It is acknowledged that when you handover mail for a Destination Mail Centre at a Handover Mail Centre you will also have mail for the Handover Mail Centre on your vehicle. Where the Handover Mail Centre is a mandatory Acceptance by Vehicle Mail Centre and you are a signatory of the Acceptance by Vehicle schedule you agree to ensure that at least 50% of the Handover Mail Centre mailing items are handed over during the pre-10:00 slot.